

Current Flow Diagram

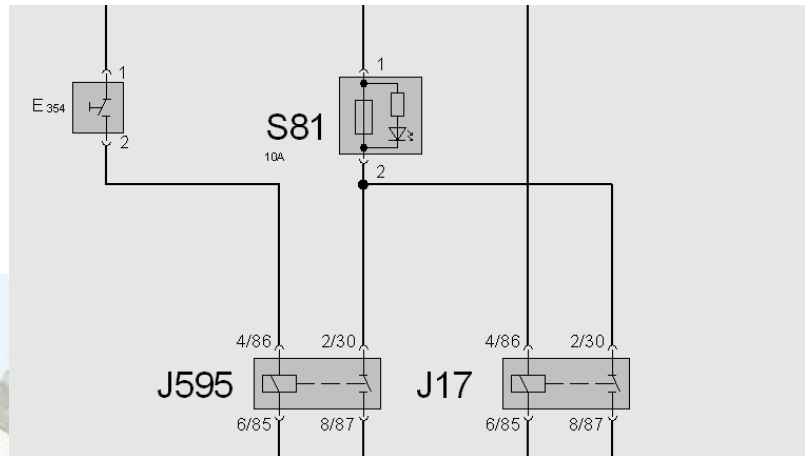

Boat Engines from Volkswagen Marine

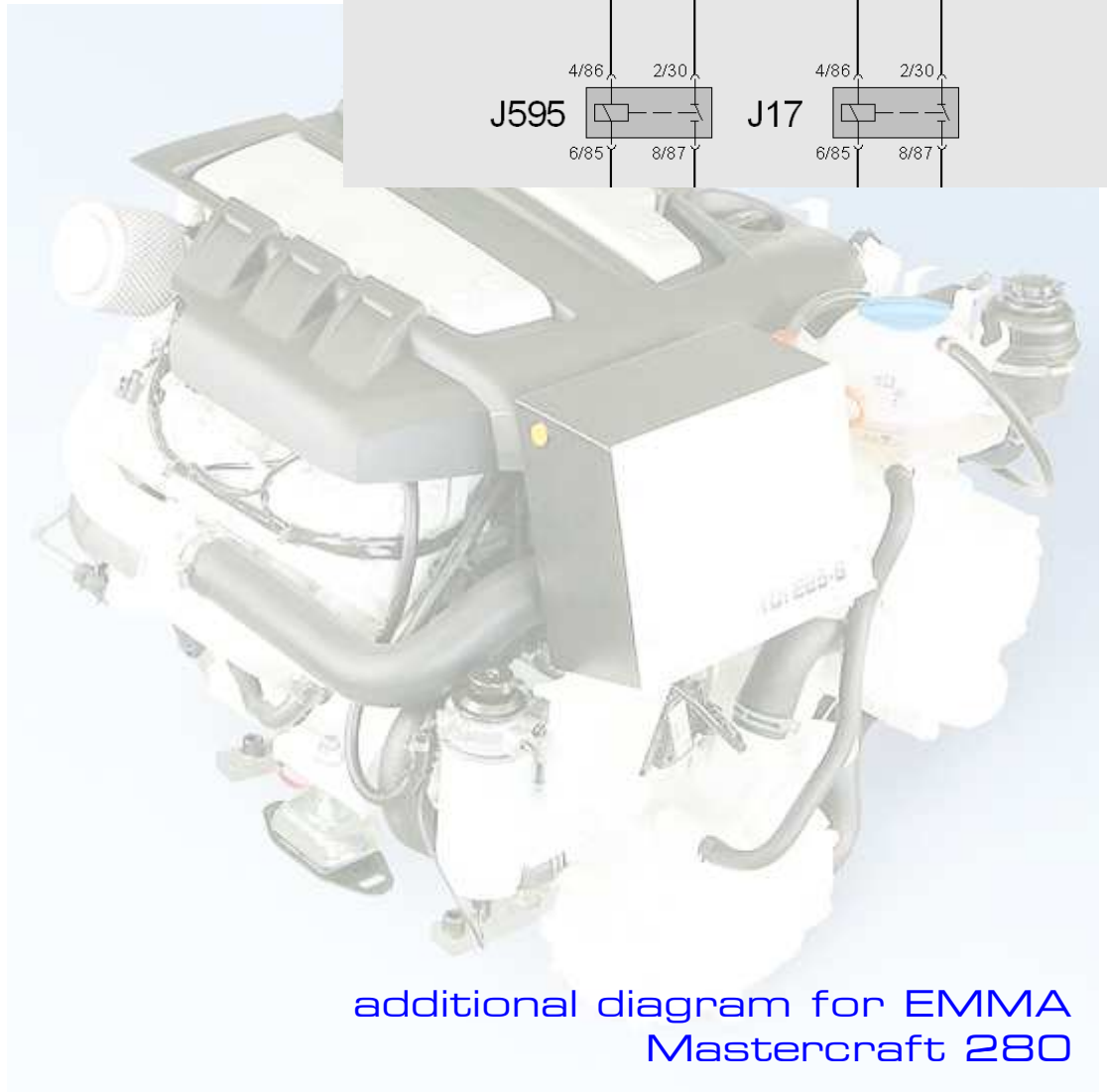

additional diagram for EMMA
Mastercraft 280

starbord

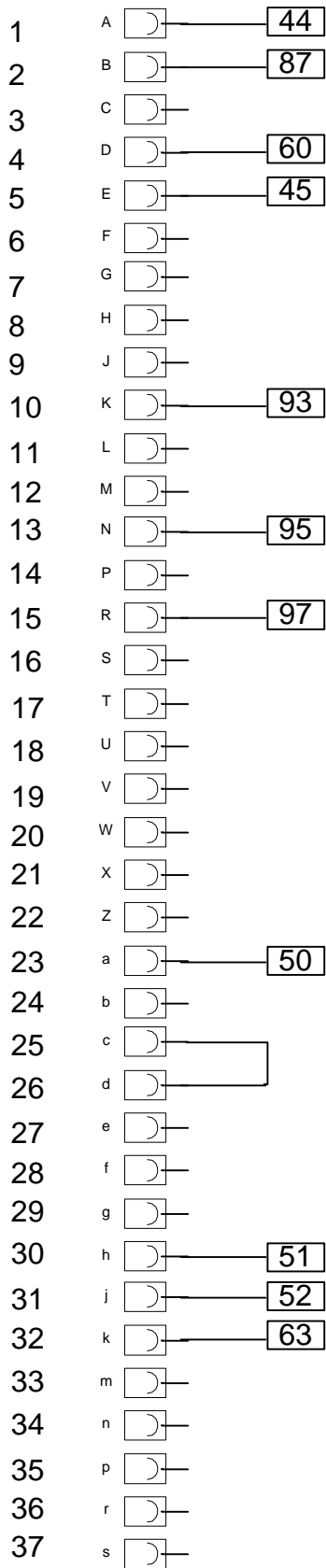

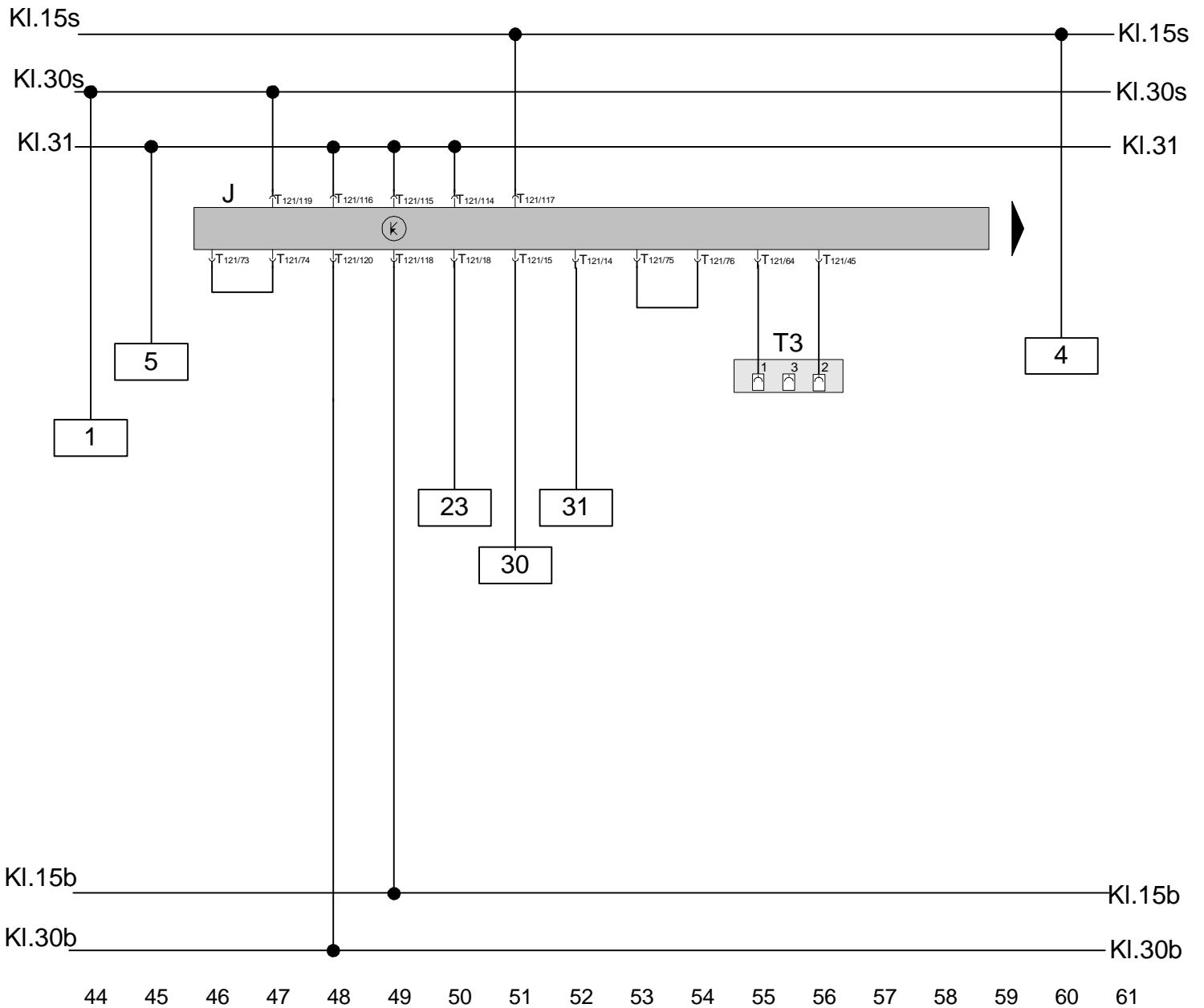

J EMMA
T3 3pin connector for EMMA diagnosis

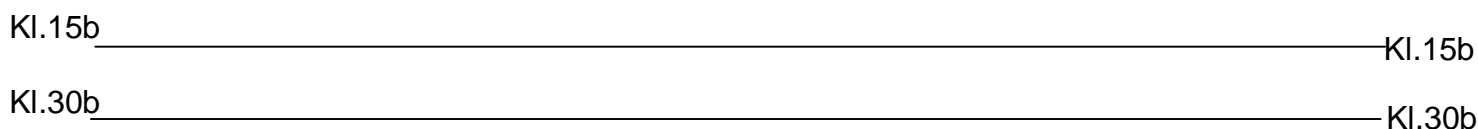
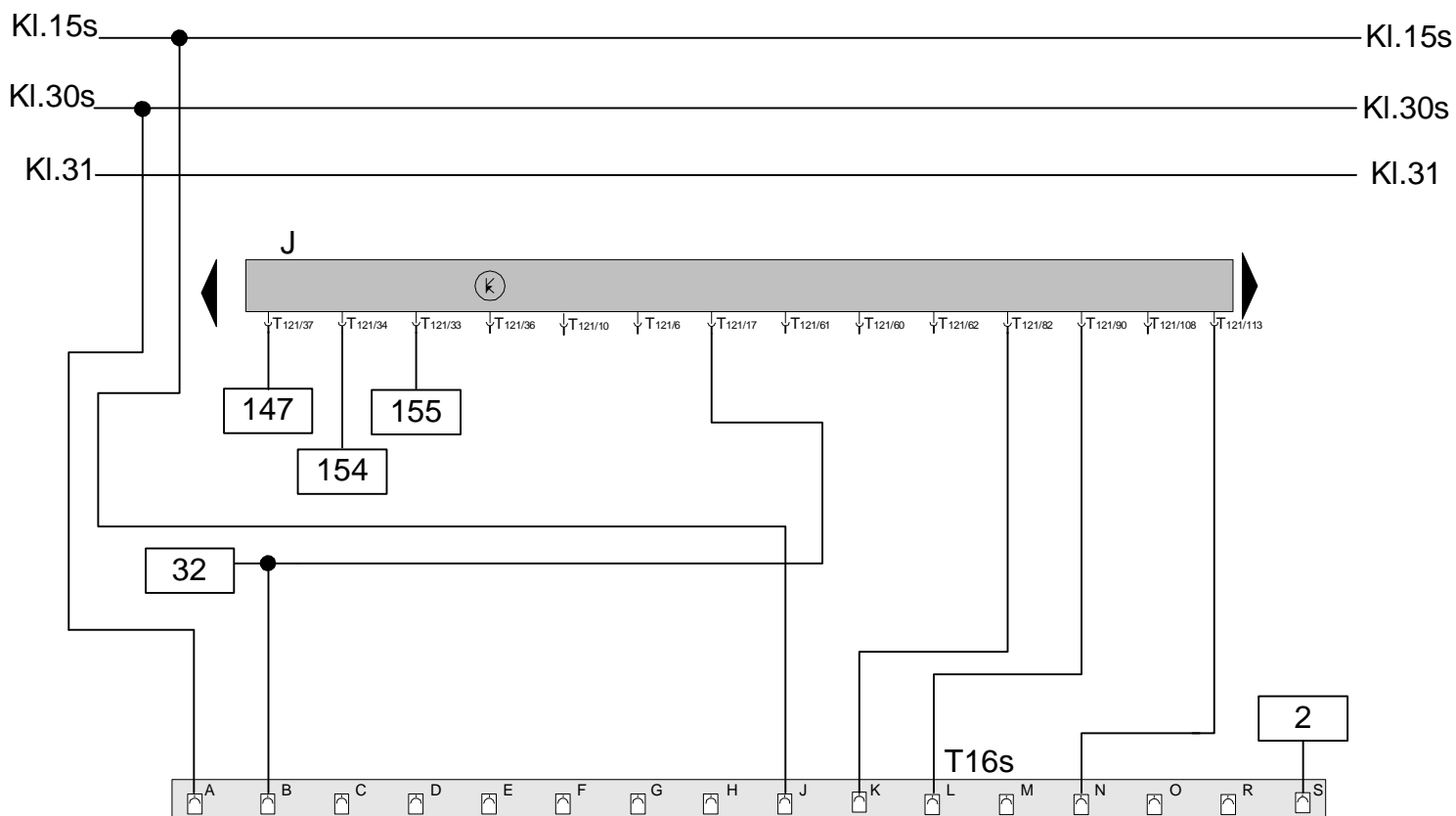

J EMMA
T16s 16pin connector to Mastercraft instrumts harness starbord

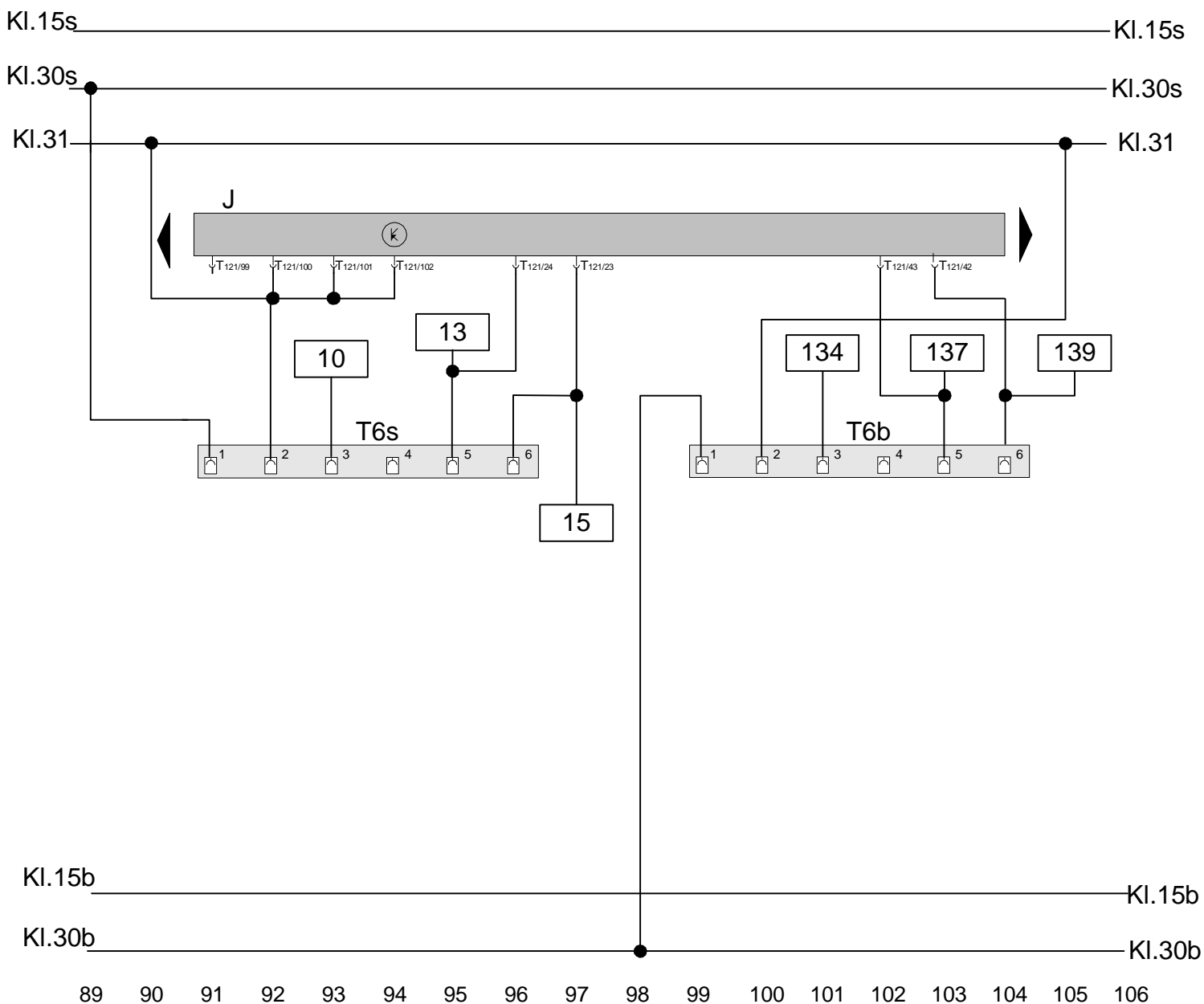

- J EMMA
- T6s 6pin connector for engine diagnosis starbord
- T6b 6pin connector for engine diagnosis port

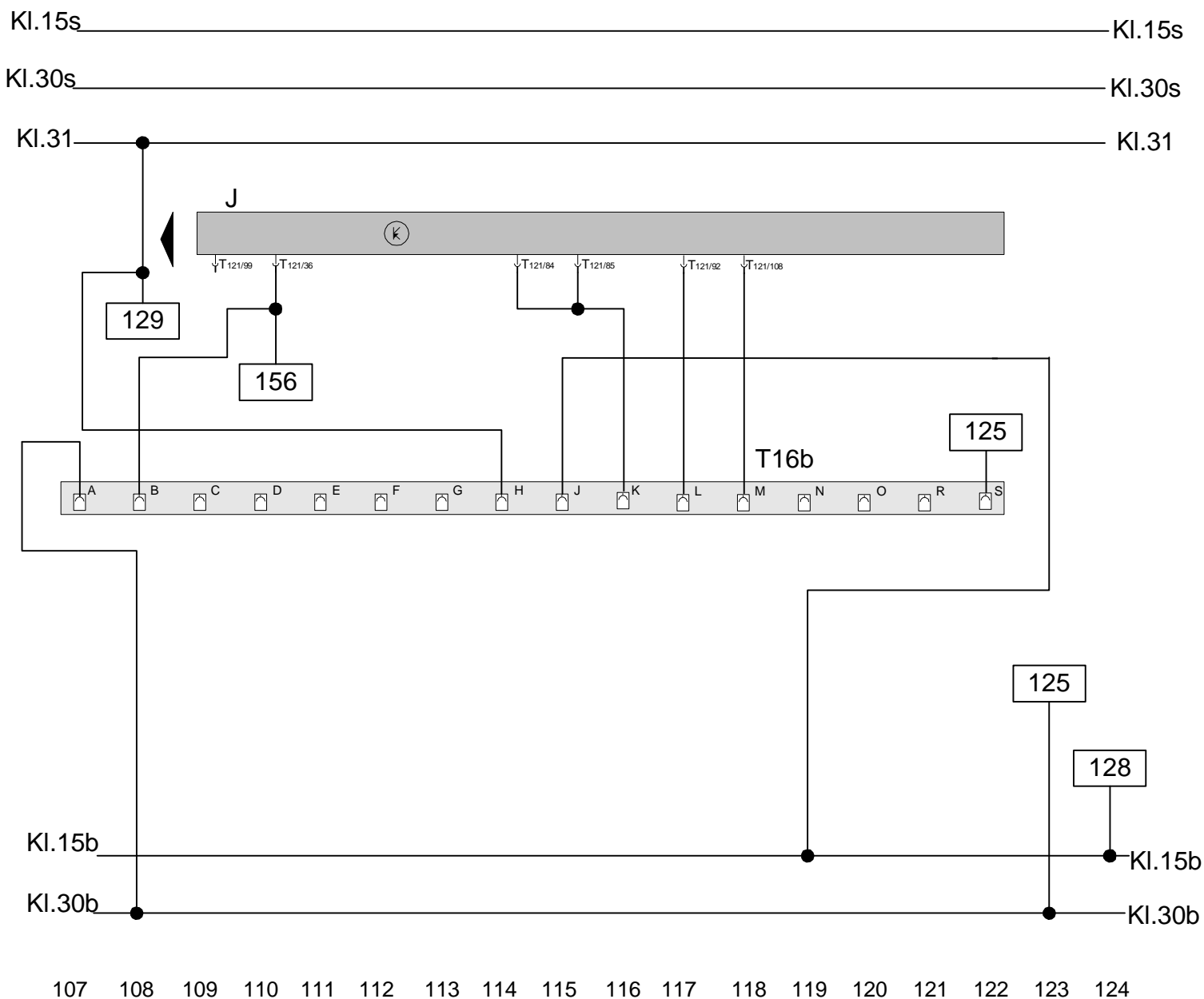

J EMMA
T16b 16pin connector to Mastercraft instrumts harness port

Backbord

