





# TABLE OF CONTENTS

---

## General Information

---

MercMonitor Gateway Models Description.....	1
MercMonitor Gateway Protocol Acceptance Description.....	5
Connection to a Non-SmartCraft Network.....	7
Basic Operation and Features.....	8
Automatic Engine Detection Feature.....	9
Alarm Warnings with Descriptive Text.....	9
Identifying and Using the Screen Categories.....	12

---

## Settings

---

Using the Light and Contrast Menu Options .....	14
Setting the Units.....	21
Available Screens.....	24
Turning the Screens On.....	24
Setting the Trim.....	47
Setting the Tanks.....	52
Setting the Alarms.....	61
Setting the External Sensors.....	67
Setting the Offsets.....	73
Setting the Clock.....	79
Smart Tow Settings.....	83
Economy (ECO) Settings.....	86
Setting the System.....	91
Reset Gauge to the Factory Default Settings.....	94
Gateway Settings.....	95
Help Menu.....	100

# TABLE OF CONTENTS

---

## Propulsion Menu

---

Using Propulsion Screens .....	103
Available Propulsion Screens .....	103
Troll Control Screen.....	108
Water Screen.....	111
Oil Screen.....	111
Peak Speed Screen.....	112
Fuel Pressure Screen.....	113
RPM Synchronize Screen.....	113
Engine Location Fuel Use .....	114
Double Screens.....	115
Analog Tachometer Screen.....	115
Analog Speedometer Screen.....	116
Volts/Hours Screen.....	116
Boost Pressure Screen.....	117
Trim Synchronize Screen.....	117
Trim/Tab Screen.....	118
Smart Tow.....	118

---

## Vessel Menu

---

Using the Vessel Screens.....	129
Available Vessel Screens.....	129
Economy (ECO) Screen.....	133
Trip Data Screen.....	138
Heating, Ventilation, and Air Conditioning Screen.....	141
Generator Screen.....	142
Range Screen.....	143
Trim Screen.....	144
Tanks.....	145
Tabs Screen.....	146
GPS Screen.....	147
To Waypoint Screen.....	148
Steering Screen.....	149
Depth Screen.....	150

# TABLE OF CONTENTS

---

## Full Screens

---

Full Screens Features and Options .....	151
---	-----

---

## Favorite Screens

---

Favorites Screen Features and Options.....	156
--	-----

---

## Alarms

---

Alarms Screen.....	162
--------------------	-----

---

## Owners Assistance

---

Local Repair Service.....	167
Service Away from Home.....	167
Parts and Accessories Inquiries.....	167
Service Assistance.....	167
Mercury Marine Service Offices.....	168
Ordering Literature.....	169



# GENERAL INFORMATION

## MercMonitor Gateway Models Description

There are four MercMonitor gateway models available; base model with nine gateway features, RPM Smart Tow model with 20 gateway features, Smart Tow Pro model with 25 gateway features (includes a GPS puck), and Gateway Premier model with 25 gateway features. Each model incorporates the use of NMEA 2000<sup>1</sup> and J1939 software interface that allows or controls access to other programs.

Each engine must have its own gateway monitor when using the base or RPM Smart Tow models. Gateway Premier and Smart Tow Pro models can communicate and provide NMEA 2000/J1939 with four engines or less. Gateway Premier and Smart Tow Pro models screen will only display single engine data. Premier does not include Smart Tow Pro control capabilities.

Base Model (single engine, NMEA 2000 support selectable)	
NMEA 2000 and J1939 in/out supported	RPM
	Voltage
	Oil pressure
	Coolant temperature
	Fuel tank level percent
NMEA 2000 only in/out supported	Fluid level percent (Fuel 2, oil, water, waste)
	Trim position
	Water pressure
	Check engine alarm <b>IMPORTANT: NMEA 2000/J1939 alarm data is limited, refer to the MercMonitor display for descriptive fault text.</b>

1. NMEA 2000 pending certification.

# GENERAL INFORMATION

RPM Smart Tow Model (single engine, NMEA 2000 support selectable)	
NMEA 2000 and J1939 in/out supported	RPM
	Voltage
	Oil pressure
	Coolant temperature
	Fuel tank level percent
	Fuel flow
	Engine hours
	Boost pressure
	Oil temperature
NMEA 2000 only in/out supported	Fluid level percent (Fuel 2, oil, water, waste)
	Trim position
	Water pressure
	Check engine alarm <b>IMPORTANT: NMEA 2000/J1939 alarm data is limited, refer to the MercMonitor display for descriptive fault text.</b>
	Tabs
	GPS speed/COG/latitude, longitude (in only)
	Depth
	Seawater temperature
	Paddle wheel speed
	Pitot speed



# GENERAL INFORMATION

Smart Tow Pro Model with GPS puck (four engine or less, NMEA 2000 support selectable)	
NMEA 2000 and J1939 in/out supported	RPM
	Voltage
	Oil pressure
	Coolant temperature
	Fuel tank level percent
	Fuel flow
	Engine hours
	Boost pressure
	Oil temperature
NMEA 2000 in/out supported (only)	Fluid level percent (Fuel 2, oil, water, waste)
	Trim position
	Water pressure
	Check engine alarm <b>IMPORTANT: NMEA 2000/J1939 alarm data is limited, refer to the MercMonitor display for descriptive fault text.</b>
	Tabs
	GPS speed/COG/latitude, longitude (in only)
	Depth
	Seawater temperature
	Paddle wheel speed
	Pitot speed
	Rudder angle
	Gear pressure (CMD diesel)
	Gear temperature (CMD diesel)
	Fuel pressure
	Capacity (English or metric)

# GENERAL INFORMATION

Gateway Premier (four engine or less, NMEA 2000 support selectable) (includes RPM Smart Tow)	
NMEA 2000 and J1939 in/out supported	RPM
	Voltage
	Oil pressure
	Coolant temperature
	Fuel tank level percent
	Fuel flow
	Engine hours
	Boost pressure
	Oil temperature
NMEA 2000 in/out supported (only)	Fluid level percent (Fuel 2, oil, water, waste)
	Trim position
	Water pressure
	Check engine alarm <b>IMPORTANT: NMEA 2000/J1939 alarm data is limited, refer to the MercMonitor display for descriptive fault text.</b>
	Tabs
	GPS speed/COG/latitude, longitude (in only)
	Depth
	Seawater temperature
	Paddle wheel speed
	Pitot speed
	Rudder angle
	Gear pressure (CMD diesel)
	Gear temperature (CMD diesel)
	Fuel pressure
	Capacity (English or metric)

# GENERAL INFORMATION

## MercMonitor Gateway Protocol Acceptance Description

Gateway is a software interface that allows or controls access to other programs through a NMEA 2000 or J1939 protocol; a backbone for communication to share information. The software is capable of transmitting (**TX**) information to, and receiving (**RX**) information from various parameter group number (PGN) products.

Gateway Modes	
Transmit (TX)	Receive (RX)
Transmits engine data to NMEA 2000/J1939 compatible display devices.	Receives data from NMEA 2000/J1939 compatible engines.
Base and RPM Smart Tow models require one MercMonitor per engine.	Each engine requires its own MercMonitor regardless of the model (base, RPM Smart Tow, Smart Tow Pro, Gateway Premier)
Gateway Premier and Smart Tow Pro models require only one MercMonitor per vessel to transmit multiengine data to multifunction displays (MFD) through the NMEA 2000/J1939 protocol.	
The MercMonitor will display one engine only regardless of the model (base, RPM Smart Tow, Smart Tow Pro, Gateway Premier).	

Mercury Engine Data to NMEA 2000 Capable Products			
Signal	PGN Name	NMEA 2000 PGN	Mode
Rated RPM	Engine Parameter Static	127498/0x1F20A	RX/TX
Coolant Pressure	Engine Parameters Rapid Dynamic	127489/0x1F201	RX/TX
Speed Over Water	Speed	128259/0x1F503	RX/TX
RPM	Engine Parameters Rapid Update	127488/0x1F200	RX/TX
Voltage	Engine Parameters Rapid Dynamic	127489/0x1F201	RX/TX
Coolant Temperature	Engine Parameters Rapid Dynamic	127489/0x1F201	RX/TX

# GENERAL INFORMATION

Mercury Engine Data to NMEA 2000 Capable Products			
Signal	PGN Name	NMEA 2000 PGN	Mode
Fuel Pressure	Engine Parameters Rapid Dynamic	127489/0x1F201	RX/TX
Fuel Level	Fluid Level	127505/0x1F211	RX/TX
Fuel Tank Size	Fluid Level	127505/0x1F211	RX/TX
Fuel Flow	Engine Parameters Rapid Dynamic	127489/0x1F201	RX/TX
Oil Pressure	Engine Parameters Rapid Dynamic	127489/0x1F201	RX/TX
Oil Temperature	Engine Parameters Rapid Dynamic	127489/0x1F201	RX/TX
Gear Temp	Transmission Dynamic	127493/0x1F205	RX/TX
Gear Pressure	Transmission Dynamic	127493/0x1F205	RX/TX
Boost Pressure	Engine Parameters Rapid Update	127488/0x1F200	RX/TX
Trim position	Engine Parameters Rapid Update	127488/0x1F200	RX/TX
Rudder Angle	Rudder	127245/0x1F10D	RX/TX
Depth	Depth	128267/0x1F50B	RX/TX
Depth Offset	Depth	128267/0x1F50B	RX/TX
Seawater Temp	Environmental Parameters	130310/0x1FD06	RX/TX
Engine hours	Engine Parameters Rapid Dynamic	127489/0x1F201	RX/TX
Manufacturer ID	Address Claim (0 x 90 = Mercury)	060928/0xEE00	RX/TX
Alarm data	Check Engine	127489/0x1F201	RX/TX
Tabs	Small Craft Status	130576/0x1FE10	RX/TX
Course over Ground	COG and SOG Rapid Update	129026/0x9F802	RX
Speed over Ground	COG and SOG Rapid Update	129026/0x9F802	RX
GPS Position	Position Rapid Update	129025/0x1F801	RX
Battery	Battery Status	127508/0x1F214	RX/TX

## GENERAL INFORMATION

Mercury Engine Data to J1939 Capable Products			
Signal	PGN Name	J1939 PGN	Mode
RPM	Electronic Engine Controller #1	61444/0xF004	TX
Voltage	Vehicle Electrical Power	65271/0xFE07	TX
Coolant Temperature	Engine Temperature #1	65262/0xFEE4	TX
Fuel Level	Dash Display	65276/0xFE0C	TX
Fuel Consumption	Fuel Economy (Liquid)	65266/0xFE02	TX
Fuel Flow	Fuel Economy (Liquid)	65266/0xFE02	TX
Oil Pressure	Engine Fluid Level/Press #1	65263/0xFEE5	TX
Boost Pressure	Inlet/Exhaust Conditions	65270/0xFE06	TX
Engine hours	Total Engine Hours	65253/0xFEE5	TX
Manufacturer ID	Address Claim (0 x 90 = Mercury)	61182/0xEEFE	TX
Alarm data (Diagnostic message supported)	Check Engine	65226/0xFECA	TX
Line-Line AC RMS Volt	Generator Set Average	65030/0xFE06	RX/TX
AC RMS Frequency	Generator Set Average	65030/0xFE06	RX/TX

### Connection to a Non-SmartCraft Network

The use of the MercMonitor on a non-SmartCraft network application requires the MercMonitor gateway set to "Receive." Failure to set the gateway to "Receive" will cause numerous faults to appear that cannot be resolved. Changing the gateway to "Receive" will clear the faults. The menu path to set the gateway to "Receive" is: **"Main Menu," > "Settings," > "Gateway," > "Gateway."**

# GENERAL INFORMATION

## Basic Operation and Features

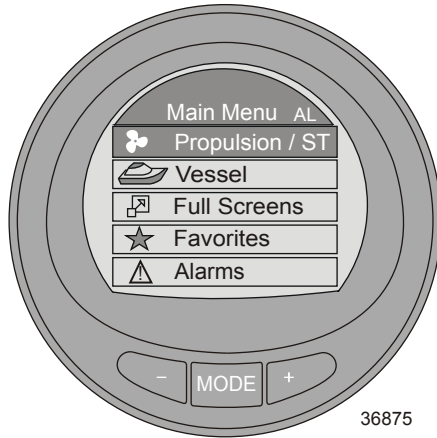

**Power up:** The gauge will power up when the ignition is turned on.

**Lights:** Adjusts the brightness and contrast of the gauge.

**Buttons:** The "MODE" button is used for selecting information screens. The "+" and "-" buttons are used for setting engine speed for cruise control, launch control, and setting gauge calibrations. To return to the previous screen, hold the "MODE" button down for three to five seconds.

**Cruise control:** Sets and controls the speed of the engine for cruising.

**Launch control:** Controls the speed of acceleration from idle to cruise speed.

**Engine Guardian System:** Monitors the critical sensors on the engine for any early indication of problems. The system will respond to a problem by reducing engine speed and alerting the operator to a potentially damaging situation.

**Warning system:** The system sounds the warning horn and displays the warning "AL" in the right corner of the "Main Menu" screen. The alarm screen will pop up, flashing a warning icon in the middle of the screen and the "AL" in the upper right side of the screen. Press the "+" button to display the descriptive text.

## GENERAL INFORMATION

**IMPORTANT:** Optional sensors such as depth, fuel, paddle wheel, and steering angle, should always be connected to the starboard engine when using SmartCraft gauges version 4.0 or later.

### Automatic Engine Detection Feature

The SmartCraft monitor has an automatic engine detection feature. This feature automatically detects which engine type is used and configures the gauge to match that engine type.

The first power up of the gauge, or after a reset all to factory default<sup>2</sup>, the gauge will display "AUTODETECT." Press the "MODE" button to start the automatic engine detection feature and the gauge will determine the engine type. This will preset the data monitoring screens to make the initial setup easier.

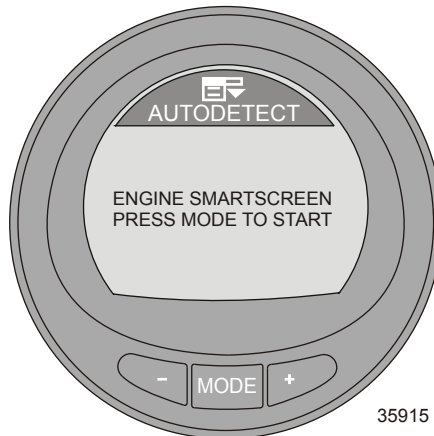

If the gauge shows a warning of "NO STARBOARD ENGINE" or "MULTIPLE STARBOARD ENGINES," the engine location (port and starboard) must be selected by an authorized dealer equipped with the computer diagnostic system (CDS) tool.

### Alarm Warnings with Descriptive Text

**IMPORTANT:** Alarm warnings and descriptive fault text are only available on the MercMonitor screen. NMEA 2000/J1939 gateway is limited to seven alarm functions.

## GENERAL INFORMATION

**NOTE:** Descriptive text alarm warning screens are displayed with Gen I (2007) engines and newer.

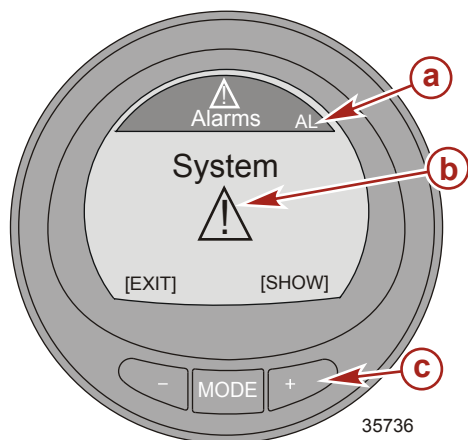

- a** - Flashing "AL" alarm
- b** - Flashing warning icon
- c** - "+" button to show descriptive text

When a problem is detected, the "AL" alarm appears and a pop-up window with the alarm location and fault number will be displayed. The faulty component or warning is described in the text. Press the "+" button for more information. This screen gives a detailed description of the fault text. Press the "+" button to view the required corrective action. The alarm message will stay displayed until the "-" button is pressed. This action will exit the warning screen. If there are multiple alarms, press the "MODE" button to view the next warning display.

If a problem can cause immediate engine damage, the Engine Guardian System will respond to the problem by limiting engine power. Immediately reduce the throttle speed to idle and refer to the warning messages. If the "MODE" button is pressed to display a different screen, the flashing alarm signal "AL" will appear in the upper right corner to indicate there still is a problem. Refer to the appropriate service manual for further explanation of the problem and the correct action to take.



# GENERAL INFORMATION

## VIEWING DESCRIPTIVE TEXT

1. When a problem is detected, the "AL" alarm will flash on the display and a pop-up window displays the system where the fault is located, the fault code, and what component is identified as a problem.

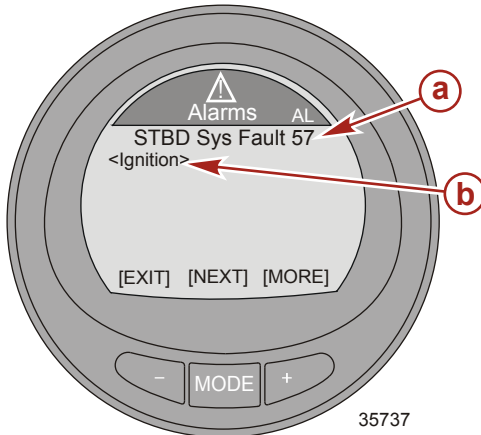

**a** - System fault and code

**b** - Component

2. Press the "+" button to view the descriptive warning text. The identified component expands to show additional text describing the fault.

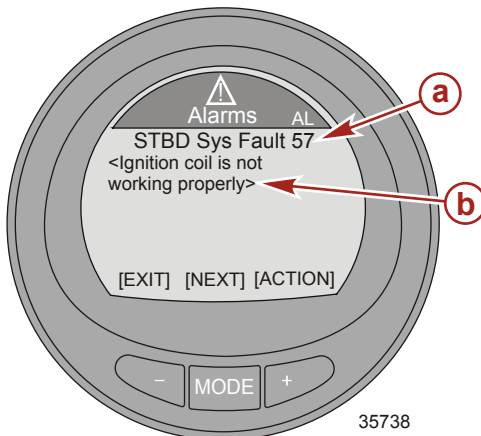

**a** - System fault and code

**b** - Additional text describing the fault

# GENERAL INFORMATION

3. Press the "+" button to view the descriptive recommended actions to proceed with.

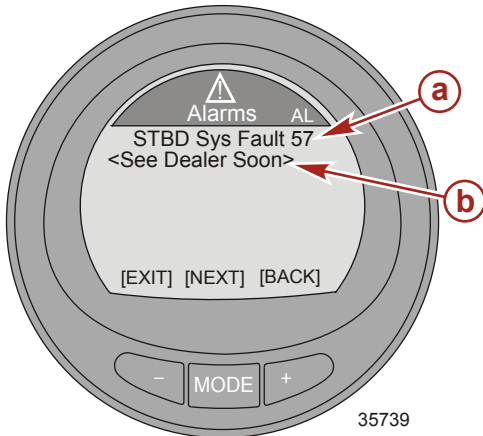

- a** - System fault and code
- b** - Recommended action

4. Press the "+" button to go back to the component identification or press the "MODE" button to view the next descriptive warning text.
5. Press the "-" button to exit the alarm screen.

## NMEA 2000/J1939 GATEWAY ALARMS

- Check Engine
- Over Temperature
- Water in fuel (WIF)
- Water Pressure
- Low Oil Pressure
- Low System Voltage
- Engine Communication Error

## Identifying and Using the Screen Categories

The monitor displays engine and vessel information through various screens. These screens can be selected to be favorites which will flash on the screen for a specific amount of time. The "Settings" menu option allows the screens to be turned off or on. The "Settings" menu option also allows the calibration of the monitor to the various different sensors like the fuel, trim, tabs, and steering to name a few.

## GENERAL INFORMATION

- **"Propulsion"** contains all screens related to the propulsion system; trim, engine performance, troll control, and Smart Tow.
- **"Vessel"** contains screens related to fuel use, tank levels, tabs, GPS data, steering position, and other items such as generators, heating, ventilation, and air conditioning (HVAC).

*NOTE: HVAC currently has no validated manufacturers.*

- **"Full Screens"** displays various information from the propulsion and vessel menu in large, easy to read letters. The full screen menu also displays some information as "Tri Data." There are five "Tri Data" screens. One of the "Tri Data" screens displays the vessel speed as known through a paddle wheel sensor or GPS, the peak vessel speed, and the RPM at that vessel speed.
- **"Favorites"** are specific screens selected by the operator to be reviewed quickly. The favorites will remain on the screen for a specific amount of time. This time can be one second up to 30 seconds. A total of nine screens can be selected from the "Propulsion" menu, "Vessel" menu, or "Full Screens" menu. Press and hold the "-" and "+" buttons down three to five seconds to add the screen to the favorites menu.
- **"Alarms"** displays information on the location, identifies, and advises a corrective action to take for all warning alarms. While in the "Alarms" category, press the "+" button for more detailed descriptive text about the fault. Press the "+" button again to review the recommended corrective action to take. Press the "MODE" button to review the next fault, or press the "-" button to exit the "Alarms" descriptive text screen.
- **"Settings"** allows the user to turn on and off screens, select a type of measurement (knots, kilometers, miles), select a screen color, adjust the contrast and brightness of the screen, select a digital or analog clock display, adjust and correct various different sensor parameters (tanks, trim, tabs), activate a GPS interface with the gauge, give the gauge a specific name (up to 12 alpha characters), and reset the gauge to the factory default settings.

# SETTINGS

## Using the Light and Contrast Menu Options

1. While in the "Main Menu," press the "-" or "+" button to highlight the "Settings" menu.
2. Press the "MODE" button to enter the "Settings" menu.

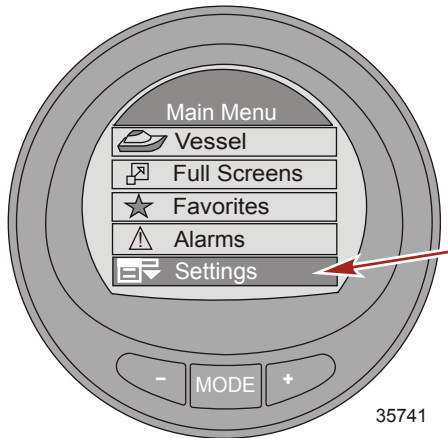

3. Press the "MODE" button to edit the "Light/Contrast" menu.

## CONTRAST

1. Press the "MODE" button to edit the "Contrast" option.
2. Press the "-" or "+" button to edit the contrast level of the monitor screen.

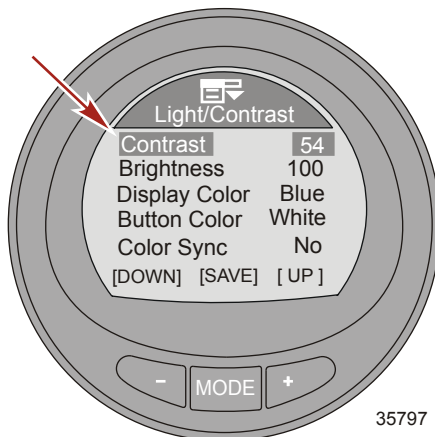

3. Press the "MODE" button to save the contrast setting.

# SETTINGS

4. To exit the "Light/Contrast" menu, press the "-" or "+" button to highlight the "Exit" option. Press the "MODE" button to exit the "Light/Contrast" menu.

## BRIGHTNESS

1. Press the "-" button to highlight the "Brightness" option.
2. Press the "MODE" button to edit the brightness of the monitor screen.
3. Press the "-" or "+" button to change the brightness of the monitor screen.

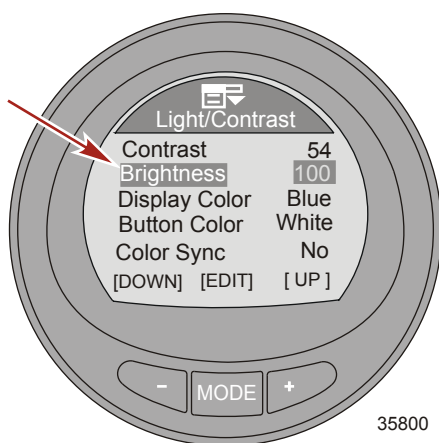

4. Press the "MODE" button to save the brightness setting.
5. To exit the "Light/Contrast" menu, press the "-" or "+" button to highlight the "Exit" option. Press the "MODE" button to exit the "Light/Contrast" menu.

## DISPLAY COLOR

The display backlighting color can be changed to red, blue, green, white, yellow, purple, and ice blue. All the monitor colors can be selected to be displayed for approximately 15 seconds each. After the 15 seconds, the color will fade and change into the next color. This is referred to as the color "Wave."

1. Press the "-" button to highlight the "Display Color" option.
2. Press the "MODE" button to edit the display color of the monitor screen.

# SETTINGS

3. Press the "-" or "+" button to select a color, or select "Wave" for the color of the monitor screen.

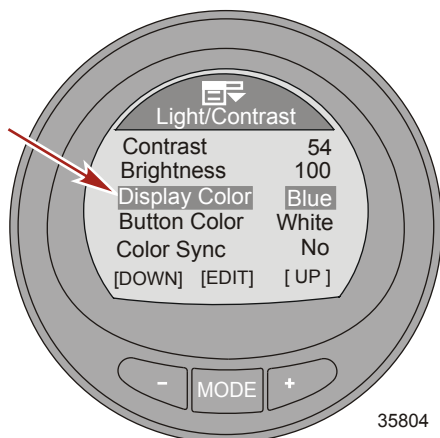

4. Press the "MODE" button to save the display color setting.
5. To exit the "Light/Contrast" menu, press the "-" or "+" button to highlight the "Exit" option. Press the "MODE" button to exit the "Light/Contrast" menu.

## BUTTON COLOR

The "-", "+", and "MODE" button light color can be changed to red, blue, green, white, yellow, purple, and ice blue. All of the button colors can be selected to be displayed for approximately 15 seconds each. After the 15 seconds, the color will fade and change into the next color. This is referred to as the color "Wave."

1. Press the "-" button to highlight the "Button Color" option.
2. Press the "MODE" button to edit the button colors.

# SETTINGS

3. Press the "-" or "+" button to select a color, or select "Wave" for the color of the buttons.

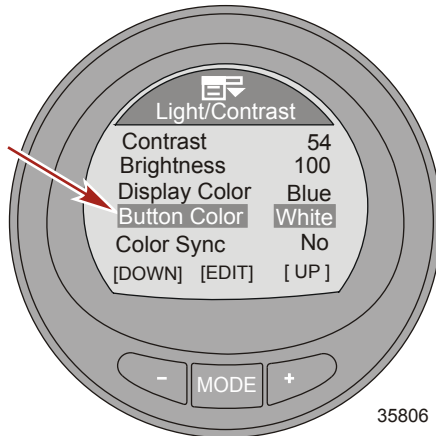

4. Press the "MODE" button to save the button color setting.
5. To exit the "Light/Contrast" menu, press the "-" or "+" button to highlight the "Exit" option. Press the "MODE" button to exit the "Light/Contrast" menu.

## COLOR SYNC

The "Color Sync" feature selects the same color for the backlight and the buttons. Turning the color synchronize on ("Yes"), turns the "Button Color" control feature off.

1. Press the "-" button to highlight the "Color Sync" option.

# SETTINGS

2. Press the "MODE" button to turn the option on ("Yes"), or turn the option off ("No").

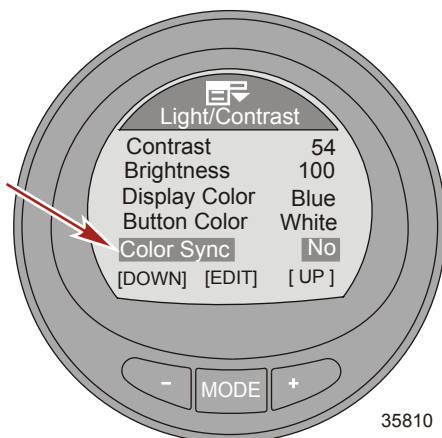

3. To exit the "Light/Contrast" menu, press the "-" or "+" button to highlight the "Exit" option. Press the "MODE" button to exit the "Light/Contrast" menu.

## REMOTE LIGHT

The "Remote Light" feature allows control of all the monitor gauge lighting from any monitor gauge. This feature controls the brightness, display color, button color, and night time mode. Two or more monitor gauges must have this feature turned on for the remote light feature to function.

1. Press the "-" button to highlight the "Remote Light" option.



# SETTINGS

2. Press the "MODE" button to turn the option on ("Yes"), or turn the option off ("No").

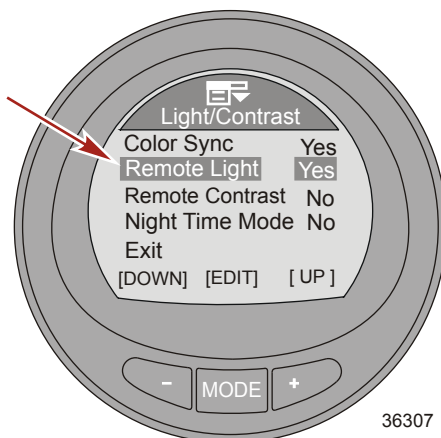

3. To exit the "Light/Contrast" menu, press the "-" or "+" button to highlight the "Exit" option. Press the "MODE" button to exit the "Light/Contrast" menu.

## REMOTE CONTRAST

The "Remote Contrast" feature allows control of all the monitor gauge contrast from any monitor gauge. This feature controls only the contrast. Two or more monitor gauges must have this feature turned on for the remote contrast feature to function.

1. Press the "-" button to highlight the "Remote Contrast" option.

# SETTINGS

2. Press the "MODE" button to turn the option on ("Yes"), or turn the option off ("No").

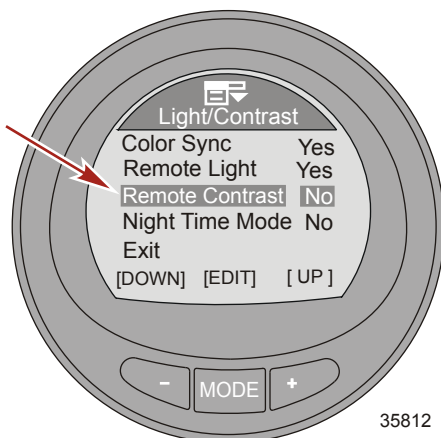

3. To exit the "Light/Contrast" menu, press the "-" or "+" button to highlight the "Exit" option. Press the "MODE" button to exit the "Light/Contrast" menu.

## NIGHT TIME MODE

"Night Time Mode" darkens the monitor screen, turning the letters and numbers to the color selected. This mode when turned on, significantly decreases the amount of backlighting on the gauge.

1. Press the "-" button to highlight the "Night Time Mode" option.

# SETTINGS

2. Press the "MODE" button to turn the option on ("Yes"), or turn the option off ("No"). A third option automatically ("AUTO") selects the "Night Time Mode" when the ambient light conditions fade.

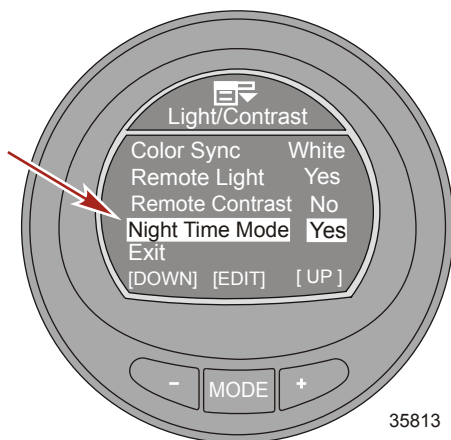

3. To exit the "Light/Contrast" menu, press the "-" or "+" button to highlight the "Exit" option. Press the "MODE" button to exit the "Light/Contrast" menu.

## Setting the Units

The "Units" menu option changes the display units of measurement to English ("Eng") or metric ("Met"), and the speed display to miles per hour ("MPH"), kilometers per hour ("KMH"), or knots ("KN").

1. While in the "Main Menu," press the "-" or "+" button to highlight the "Settings" menu.

# SETTINGS

2. Press the "MODE" button to enter the "Settings" menu.

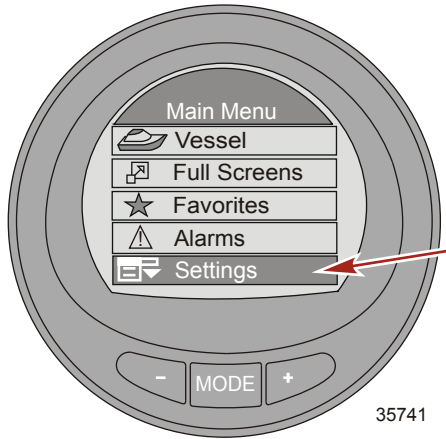

3. Press the "-" button to highlight the "Units" menu.

4. Press the "MODE" button to edit the "Units" menu.

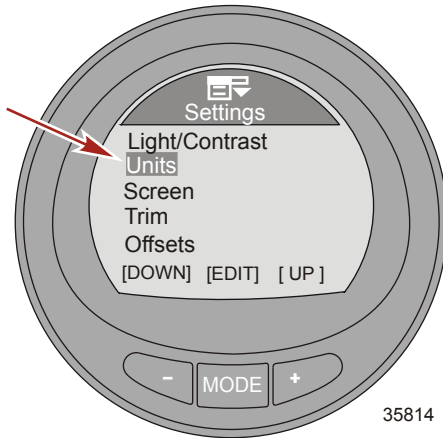

## SETTINGS

5. Press the "MODE" button to change the display units to English ("Eng"), or metric ("Met").

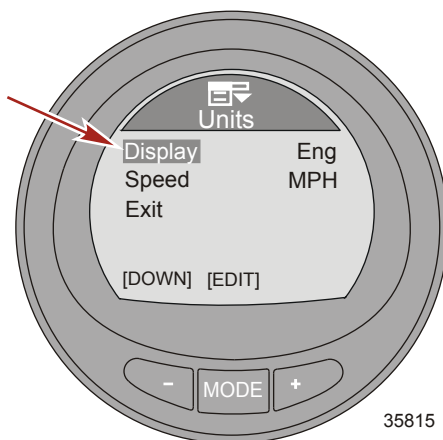

6. Press the "-" button to highlight the "Speed" unit.
7. Press the "MODE" button to change the speed units to miles per hour ("MPH"), kilometers per hour ("KMH"), or knots ("KN").

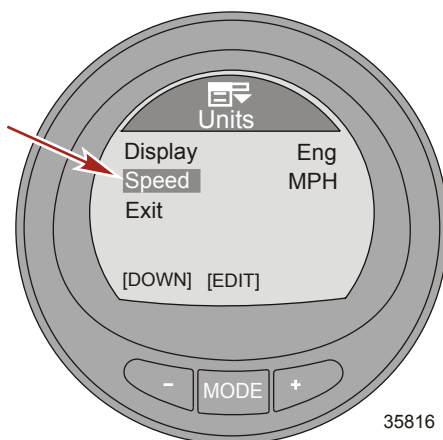

8. Press the "-" button to highlight the "Exit" option. Press the "MODE" button to exit the "Units" menu.

# SETTINGS

## Available Screens

Within the "Screens" menu, screens can be turned off or on. The "Full Screens" sub-menu has eight full screens that can be turned off or on. Additionally within the "Full Screens" sub-menu, there are up to five screens that are user modified and are called "Tri Data" that displays three user selected and arranged propulsion or vessel data. Screens that are turned off or on also have a direct relation to the various screens in the propulsion and vessel menus, and are dependant on the power package installed that supports the different sensors.

- Full screens
- Double screen
- ECO screen
- Quick reference
- Analog RPM
- Analog speed
- Trim and RPM
- Peak speed
- Water information
- Oil information
- Fuel pressure
- Volts and hours
- Fuel used
- Depth
- Steering position
- Boost pressure
- Tabs
- GPS data
- Waypoint
- Temperature 2
- Troll control
- Smart Tow
- HVAC (Currently no validated manufacturers)
- Generator
- Screen synchronize
- Favorite slides

## Turning the Screens On

### FULL SCREENS OPTIONS

1. While in the "Main Menu," press the "-" or "+" button to highlight the "Settings" menu.

# SETTINGS

2. Press the "MODE" button to enter the "Settings" menu.

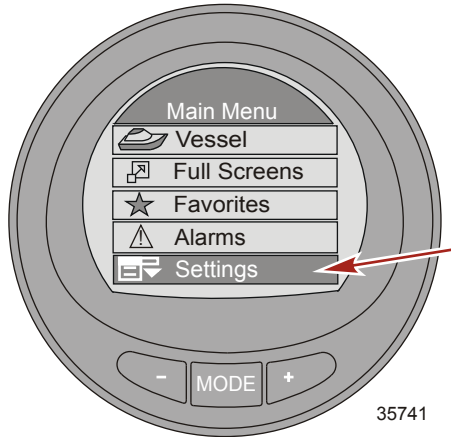

3. Press the "-" button to highlight the "Screens" menu.
4. Press the "MODE" button to edit the "Screens" menu.

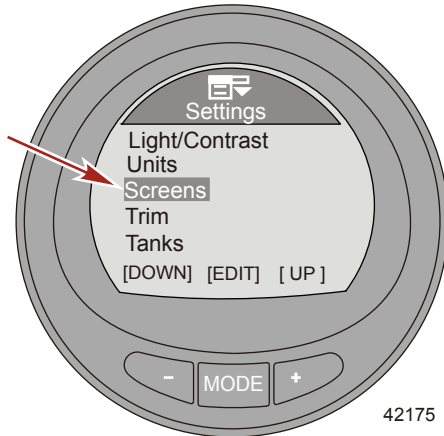

# SETTINGS

5. Press the "MODE" button to edit the "Full Screens" menu.

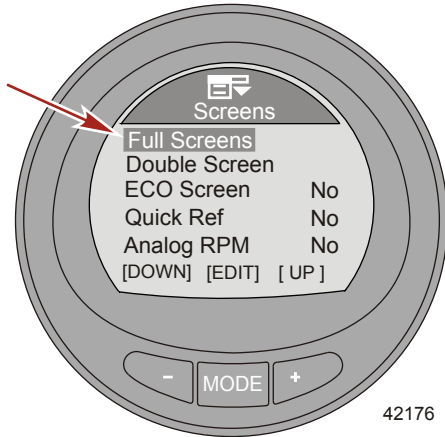

6. Press the "MODE" button to turn the "Speed" option on ("Yes") or off ("No").

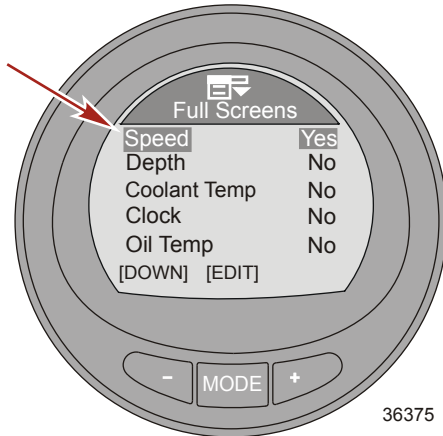

7. Press the "-" button to highlight the "Depth" option.



# SETTINGS

8. Press the "MODE" button to turn the "Depth" option on ("Yes") or off ("No").

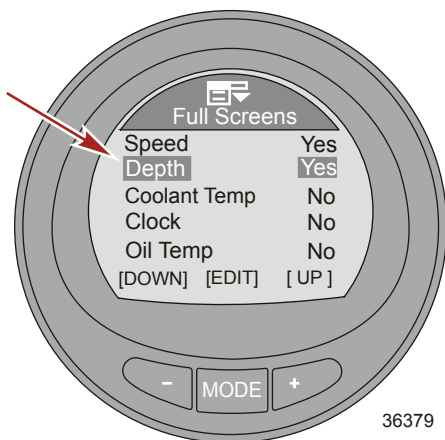

9. Press the "-" button to highlight the "Coolant Temp" option.  
10. Press the "MODE" button to turn the "Coolant Temp" option on ("Yes") or off ("No").

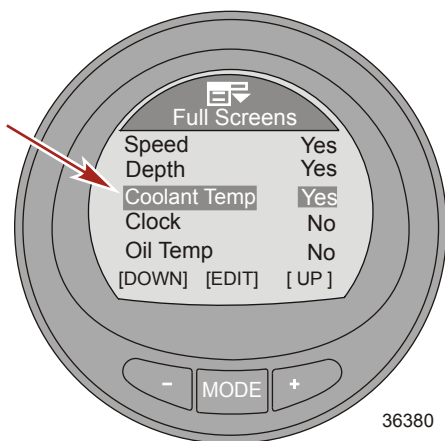

11. Press the "-" button to highlight the "Clock" option.

# SETTINGS

12. Press the "MODE" button to edit the "Clock" option to off ("NO"). Press the "MODE" button again to change the clock to an "Analog" display, or press the "MODE" button again to change the display to "Digital."

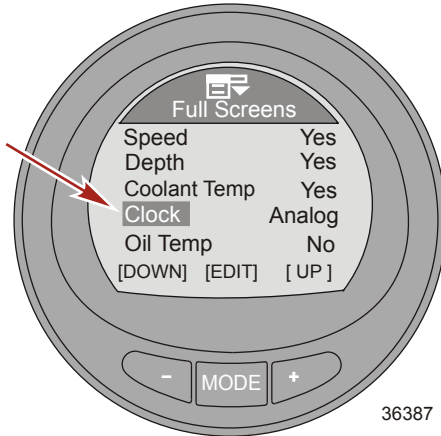

13. Press the "-" button to highlight the "Oil Temp" option.  
14. Press the "MODE" button to turn the "Oil Temp" option on ("Yes") or off ("No").

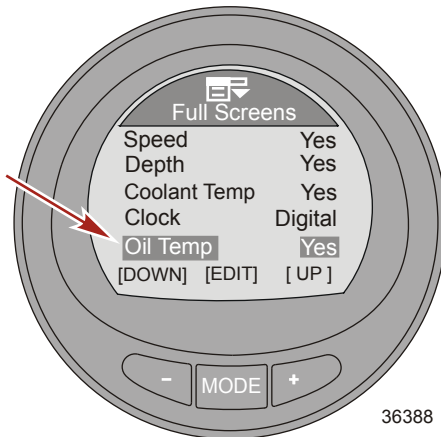

15. Press the "-" button to highlight the "Fuel Pressure" option.

# SETTINGS

16. Press the "MODE" button to turn the "Fuel Pressure" option on ("Yes") or off ("No").

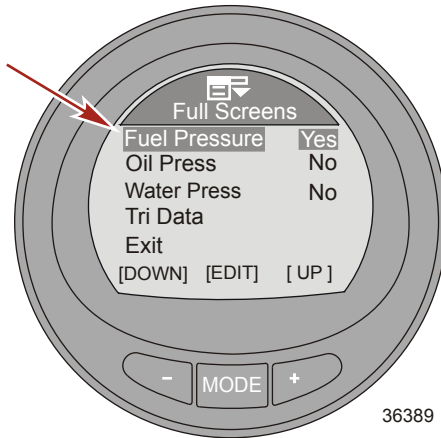

17. Press the "-" button to highlight the "Oil Press" option.

18. Press the "MODE" button to turn the "Oil Press" option on ("Yes") or off ("No").

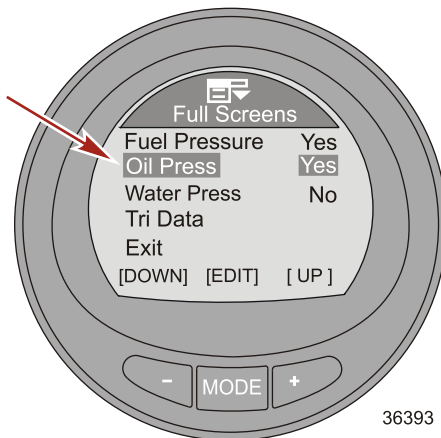

19. Press the "-" button to highlight the "Water Press" option.

# SETTINGS

20. Press the "MODE" button to turn the "Water Press" option on ("Yes") or off ("No").

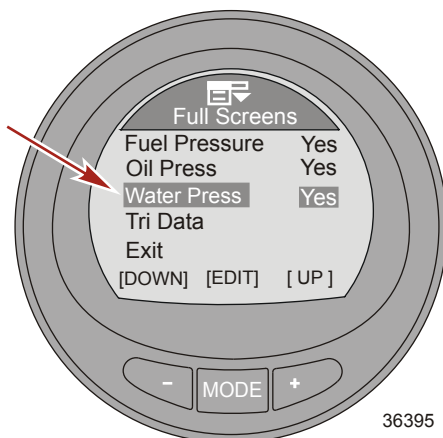

21. Press the "-" button to highlight the "Tri Data" menu.

22. Press the "MODE" button to edit the "Tri Data" option.

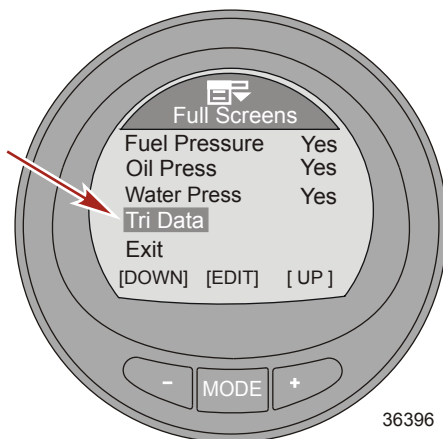

# SETTINGS

23. The first "Tri Data" screen is turned on ("Yes") by default. To edit "Screen 1," press the "MODE" button twice.

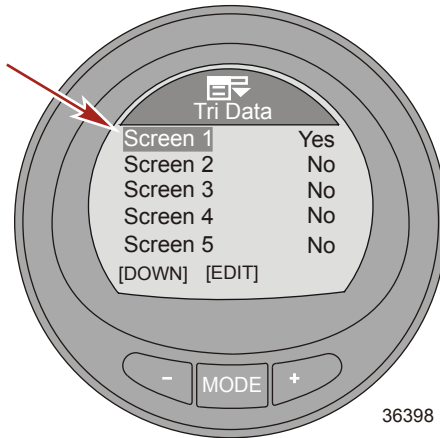

24. Press the "MODE" button to edit the "Top" screen option.

25. Press the "-" or "+" button to change the "Top" data information.

**NOTE:** The information available for the "Top," "Left," and "Right" "Tri Data" is: "Hours," "Clock," "Depth," "Temp 2," "Fuel," "RPM," "Speed," "Coolant Temp," "Oil Temp," "Seatemp," "Water Press," "Oil Press," "Trim," "Fuel Flow," and "Battery."

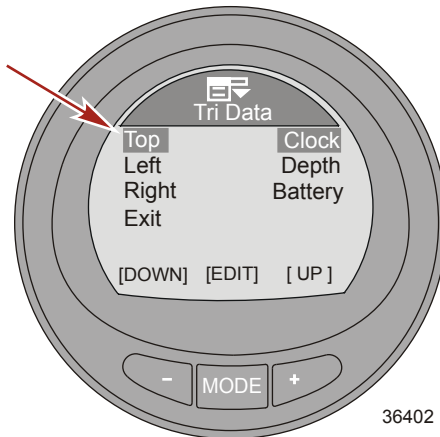

26. Press the "MODE" button to exit the "Top" screen data option.

27. Press the "-" button to highlight the "Left" screen option.

# SETTINGS

28. Press the "MODE" button to edit the "Left" screen option.

29. Press the "-" or "+" button to change the left side data information.

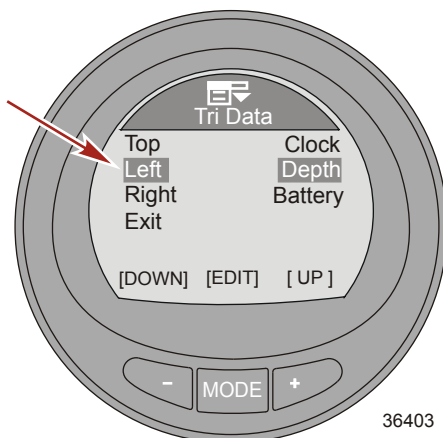

30. Press the "MODE" button to exit the "Left" screen data option.

31. Press the "-" button to highlight the "Right" screen option.

32. Press the "MODE" button to edit the "Right" screen option.

33. Press the "-" or "+" button to change the right side data information.

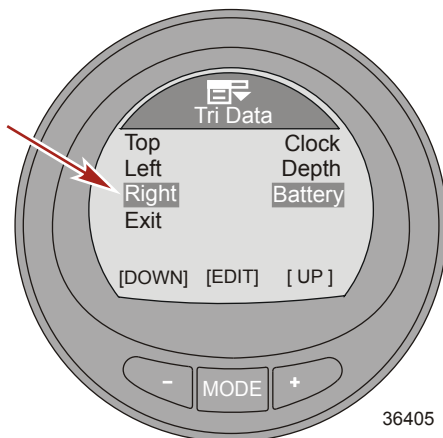

34. Press the "MODE" button to exit the "Right" screen data option.

35. Press the "-" button to highlight the "Exit" option.

36. Press the "MODE" button to exit the "Screen 1" option.

# SETTINGS

37. Press the "-" button to highlight the "Screen 2" menu.
38. Press the "MODE" button to turn "Screen 2" on ("Yes") and to edit the available data. Complete the process as explained in steps 24 through 36 for additional "Tri Data" screens.
39. When finished with the "Tri Data" screens, press the "-" button to highlight the "Exit" option. Press the "MODE" button to exit the "Full Screens" menu.

## DOUBLE SCREEN

1. While in the "Screens" menu, press the "-" button to highlight the "Double Screen" menu.
2. Press the "MODE" button to edit the "Double Screen" option.

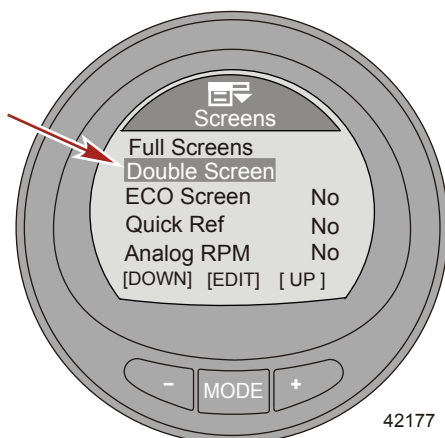

# SETTINGS

3. The first screen is turned on ("Yes") by default. To edit "Screen 1," press the "MODE" button twice.

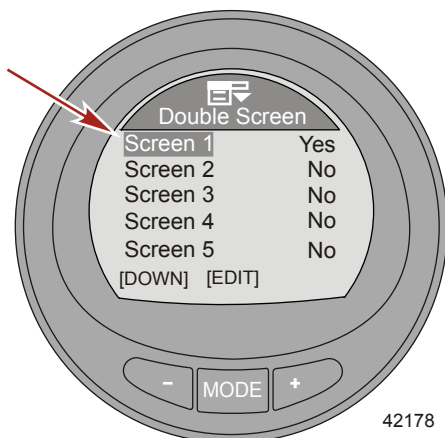

4. Press the "MODE" button to edit the "OUTER" screen data option.
5. Press the "-" or "+" button to change the "OUTER" data information.

**NOTE:** The information available for the "OUTER" and "INNER" "Double Screen" is: "RPM," "Speed," "Coolant Temp," "Oil Temp," "Seatemp," "Water Press," "Oil Press," "Fuel Flow," "Fuel," "Battery," "Depth," and "Temp 2."

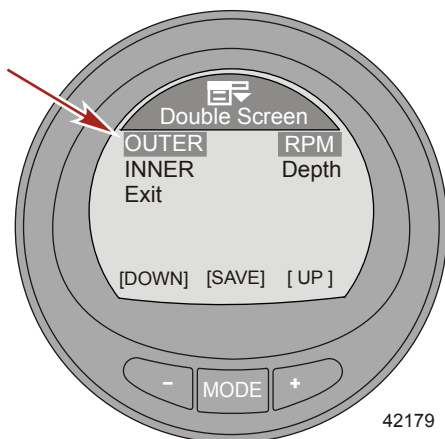

6. Press the "MODE" button to exit the "OUTER" screen data option.
7. Press the "-" to highlight the "INNER" screen data option.



## SETTINGS

8. Press the "MODE" button to edit the "INNER" screen data option.
9. Press the "-" or "+" button to change the "INNER" data information.

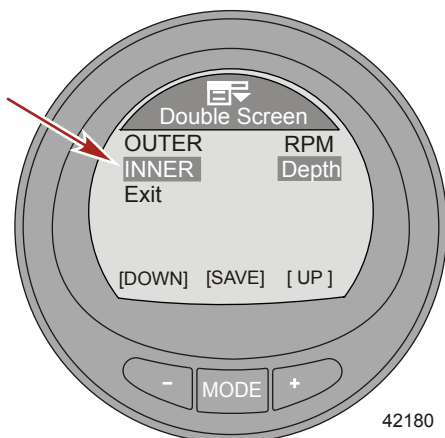

10. Press the "MODE" button to exit the "INNER" screen data option.
11. Press the "-" to highlight the "Exit" option.
12. Press the "MODE" button to exit the "Screen 1" option.
13. Press the "-" to highlight the "Screen 2" menu.
14. Press the "MODE" button to turn "Screen 2" on ("Yes") and to edit the available data. Complete the process as explained in steps 4 through 11 for additional "Double Screen" options.
15. When finished with the "Double Screen" options, press the "-" button to highlight the "Exit" option. Press the "MODE" button to exit the "Double Screen" menu.

### ADDITIONAL SCREENS OPTIONS

1. While in the "Screens" menu, press the "-" button to highlight the "ECO Screen" option.

# SETTINGS

2. Press the "MODE" button to turn the option on ("Yes") or off ("No").

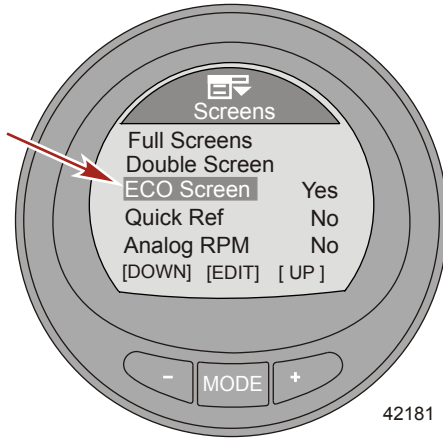

3. Press the "-" button to highlight the "Quick Ref" option.
4. Press the "MODE" button to turn the option on ("Yes") or off ("No").

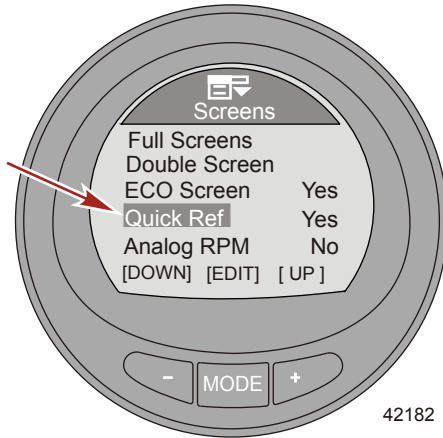

5. Press the "-" button to highlight the "Analog RPM" option.

# SETTINGS

6. Press the "MODE" button to turn the option on ("Yes") or off ("No").

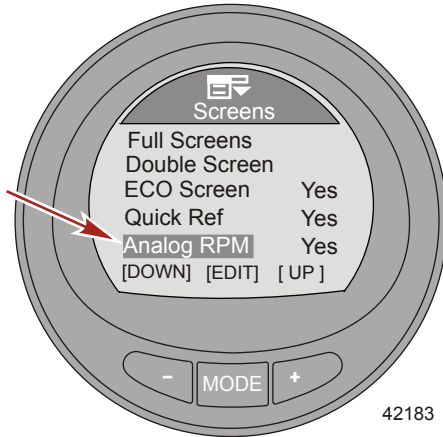

7. Press the "-" button to highlight the "Analog Speed" option.
8. Press the "MODE" button to turn the option on ("Yes") and to select the maximum speed of the analog gauge.

**NOTE:** Pressing the "MODE" button will page through the 0–80 ("80 Dial"), 0–120 ("120 Dial"), and off ("No").

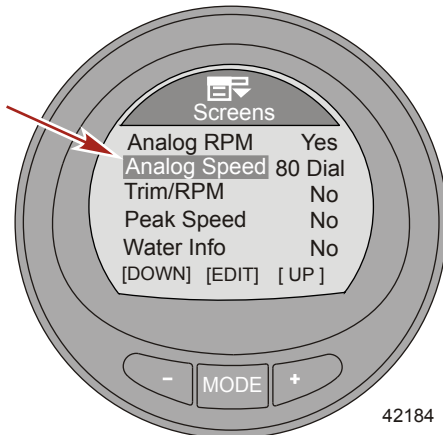

9. Press the "-" button to highlight the "Trim/RPM" option.

# SETTINGS

10. Press the "MODE" button to turn the option on ("Yes") or off ("No").

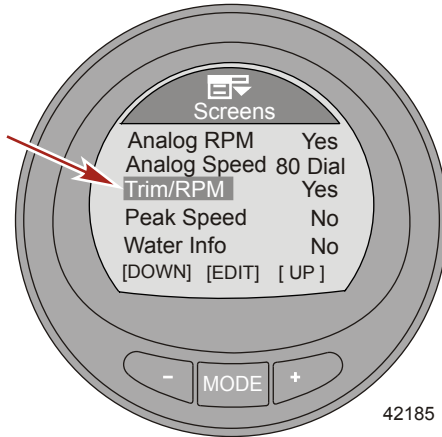

11. Press the "-" button to highlight the "Peak Speed" option.

12. Press the "MODE" button to turn the option on ("Yes") or off ("No").

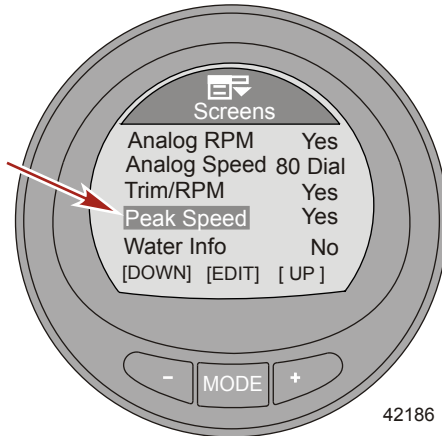

13. Press the "-" button to highlight the "Water Info" option.

# SETTINGS

14. Press the "MODE" button to turn the option on ("Yes") or off ("No").

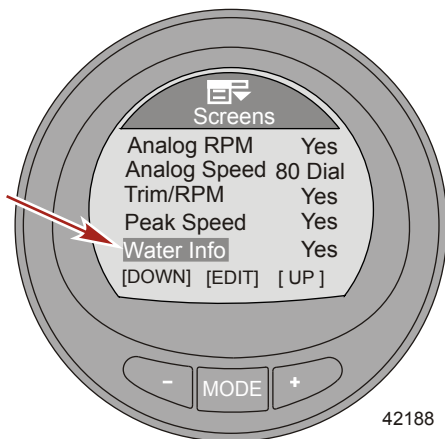

15. Press the "-" button to highlight the "Oil Info" option.

16. Press the "MODE" button to turn the option on ("Yes") or off ("No").

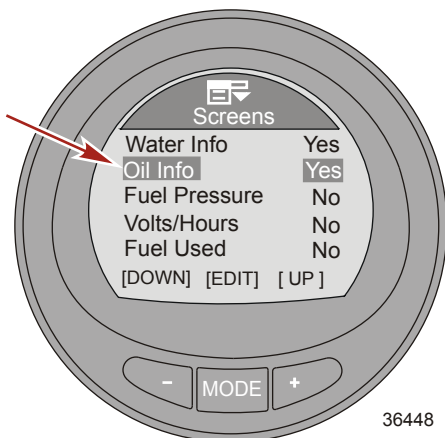

17. Press the "-" button to highlight the "Fuel Pressure" option.

# SETTINGS

18. Press the "MODE" button to turn the option on ("Yes") or off ("No").

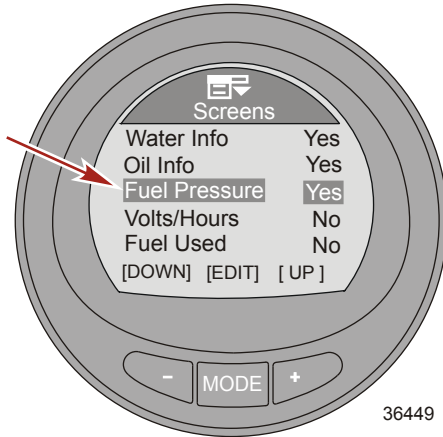

19. Press the "-" button to highlight the "Volts/Hours" option.

20. Press the "MODE" button to turn the option on ("Yes") or off ("No").

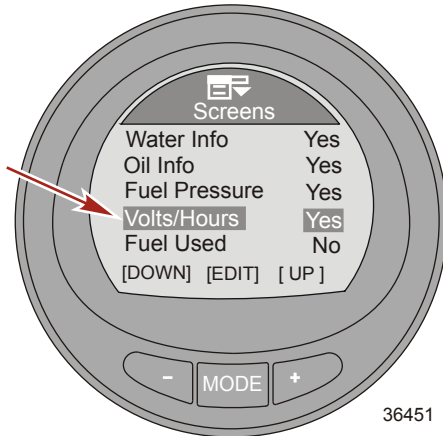

21. Press the "-" button to highlight the "Fuel Used" option.

# SETTINGS

22. Press the "MODE" button to turn the option on ("Yes") or off ("No").

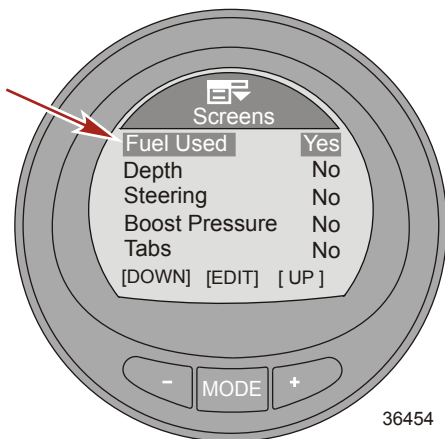

23. Press the "-" button to highlight the "Depth" option.

24. Press the "MODE" button to turn the option on ("Yes") or off ("No").

**NOTE:** The "Depth" screen must be turned on to enable the depth alarms.

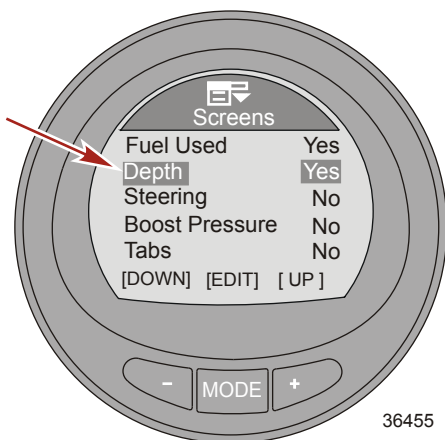

25. Press the "-" button to highlight the "Steering" option.

# SETTINGS

26. Press the "MODE" button to turn the option on ("Yes") or off ("No").

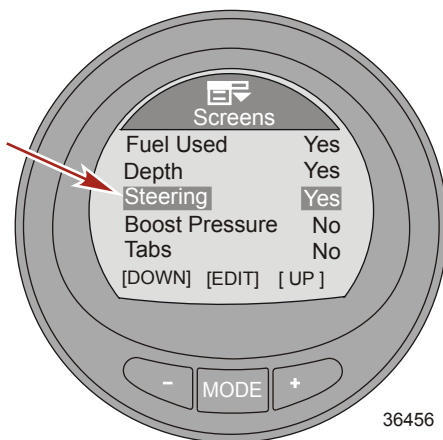

27. Press the "-" button to highlight the "Boost Pressure" option.

28. Press the "MODE" button to turn the option on ("Yes") or off ("No").

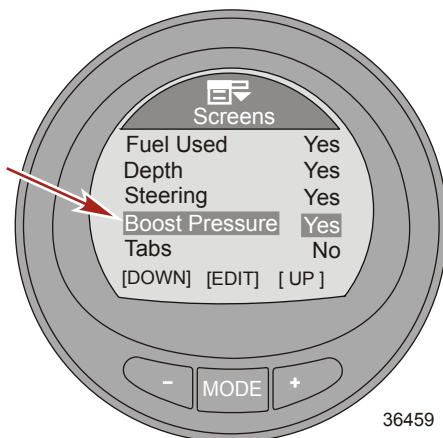

29. Press the "-" button to highlight the "Tabs" option.



# SETTINGS

30. Press the "MODE" button to turn the option on ("Yes") or off ("No").

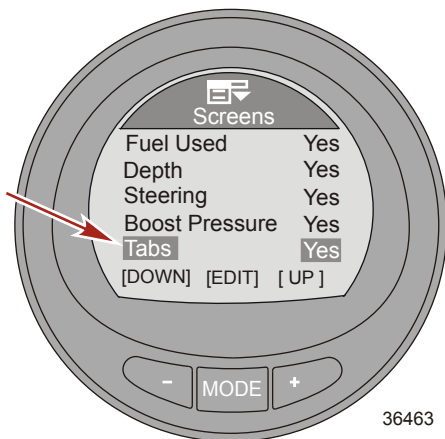

31. Press the "-" button to highlight the "GPS Data" option.

32. Press the "MODE" button to turn the option on ("Yes") or off ("No").

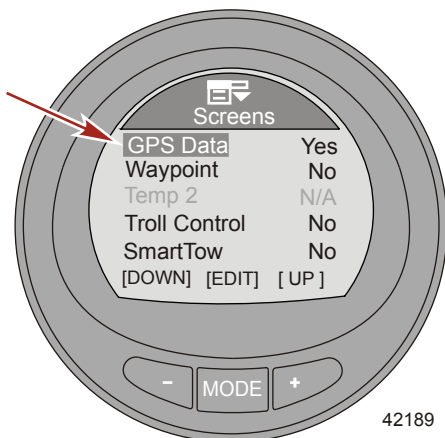

33. Press the "-" button to highlight the "Waypoint" option.

# SETTINGS

34. Press the "MODE" button to turn the option on ("Yes") or off ("No").

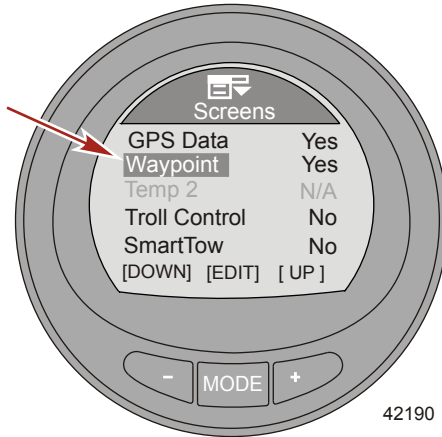

35. Press the "-" button to bypass the "Temp 2" option and move to the "Troll Control" option.

**NOTE:** The "Temp 2" option is not available at the time of this document printing.

36. Press the "MODE" button to turn the option on ("Yes") or off ("No").

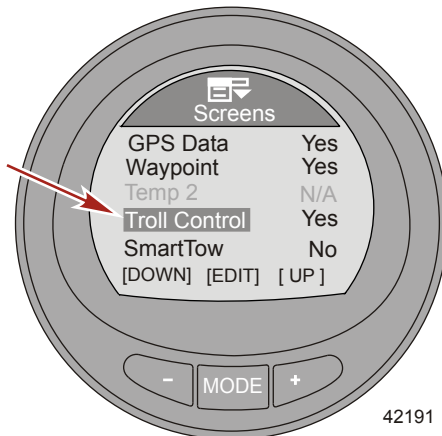

37. Press the "-" button to highlight the "SmartTow" option.

# SETTINGS

38. Press the "MODE" button to turn the option on ("Yes") or off ("No").

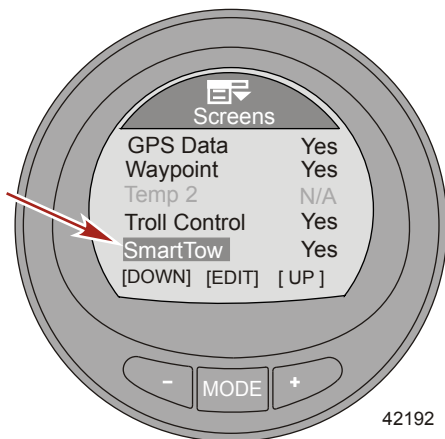

39. Press the "-" button to highlight the "HVAC System" option.

**NOTE:** HVAC currently has no validated manufacturers.

40. Press the "MODE" button to turn the option on ("Yes") or off ("No").

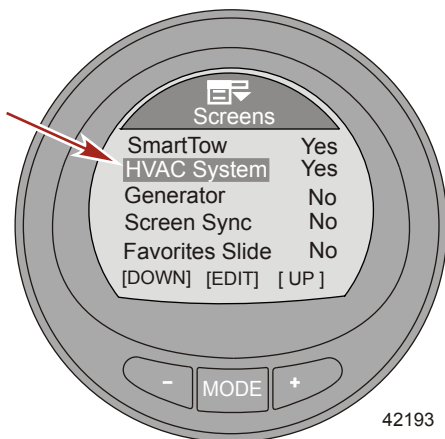

41. Press the "-" button to highlight the "Generator" option.

# SETTINGS

42. Press the "MODE" button to turn the option on ("Yes") or off ("No").

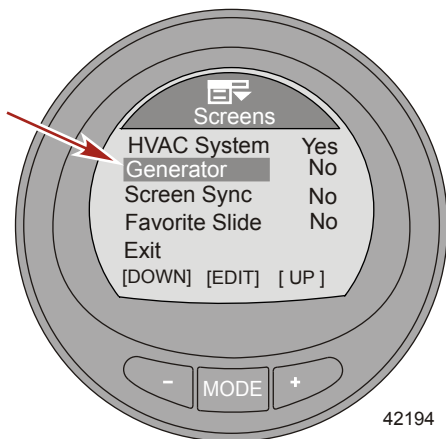

43. Press the "-" button to highlight the "Screen Sync" option.

44. Press the "MODE" button to turn the option on ("Yes") or off ("No").

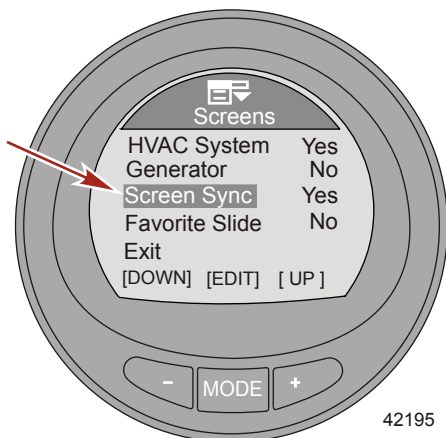

45. Press the "-" button to highlight the "Favorite Slide" option.

**NOTE:** The "Favorite Slide" seconds must be displayed for the "Favorites" menu option to function. Select from 1–30 seconds to display the selected favorites.

46. Press the "MODE" button to edit the number of seconds the favorites will display.

# SETTINGS

47. Press the "+" or "-" to change the number of seconds.

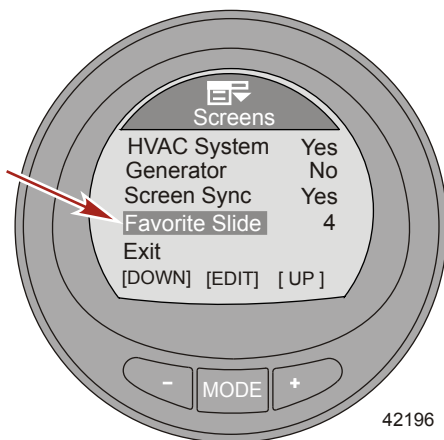

48. Press the "MODE" button to exit the "Favorite Slide" option.

49. Press the "-" button to highlight the "Exit" option. Press the "MODE" button to exit the "Screens" menu.

## Setting the Trim

Editing the trim settings menu allows you to turn the trim pop-up on or off, change the length of time the pop-up window remains on the screen, turn the high resolution on or off, and calibrate the gauge to the sensor. A high resolution setting will cause the monitor to display the trim position with more detailed information.

1. While in the "Main Menu," press the "-" or "+" button to highlight the "Settings" menu.

# SETTINGS

2. Press the "MODE" button to enter the "Settings" menu.

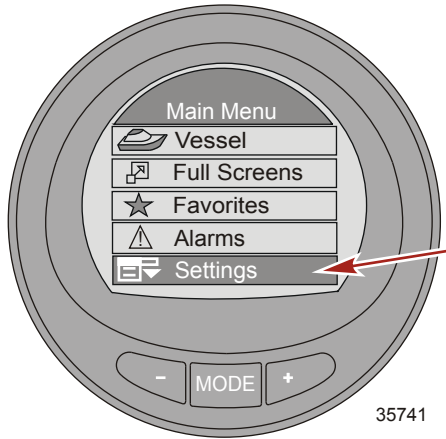

3. Press the "-" button to highlight the "Trim" menu.

4. Press the "MODE" button to edit the "Trim" menu.

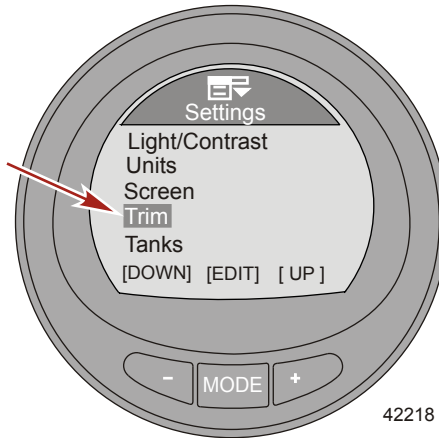

# SETTINGS

5. Press the "MODE" button to turn the trim "Popup" window option on ("Yes") or off ("No").

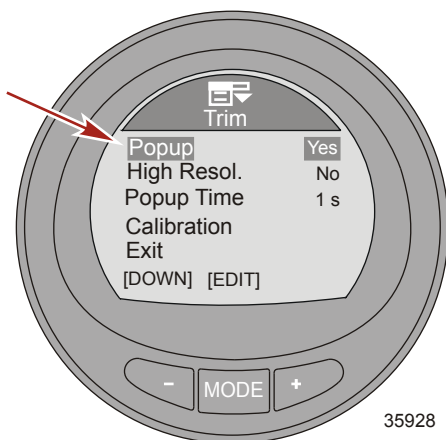

6. Press the "-" button to highlight the "High Resol" option.
7. Press the "MODE" button to turn the high resolution option on ("Yes") or off ("No").

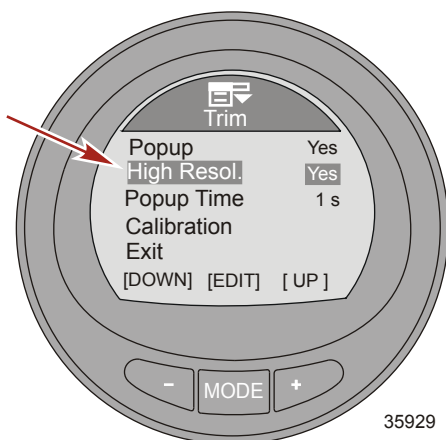

8. Press the "-" button to highlight the "Popup Time" option.
9. Press the "MODE" button to edit the length of time the trim pop-up window option remains on the screen.

# SETTINGS

10. Press the "-" or "+" to change the length of time the trim pop-up window option remains on the screen. The trim pop-up window length of time can be changed from 1 to 10 seconds.

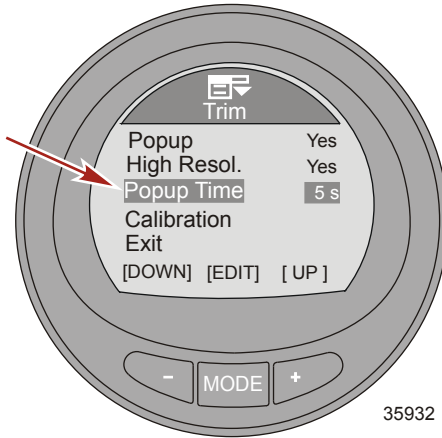

11. Press the "MODE" button to exit the "Popup Time" option.  
12. Press the "-" button to highlight the "Calibration" option.  
13. Press the "MODE" button to calibrate the gauge to the trim position sensor. An instruction window will pop-up stating to trim full down and press the "+" button when ready.

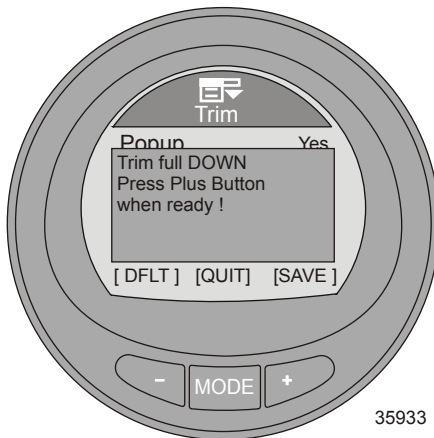

14. After pressing the "+" button, the pop-up window instructions will change stating to trim full up and press the "+" button when ready.



# SETTINGS

**IMPORTANT:** To achieve accurate trim full up calibration, this must be performed on the water while the vessel is running at cruising speed. While at cruising speed, trim up to the maximum trim angle before the vessel begins to porpoise then press the "+" button.

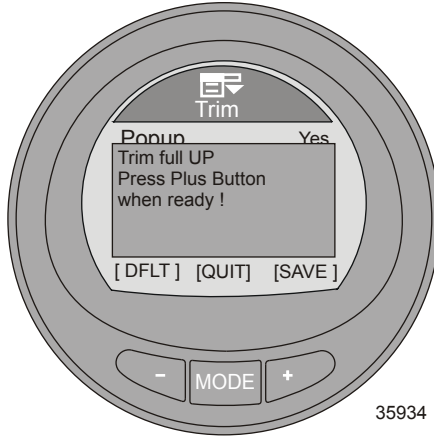

15. After pressing the "+" button, the pop-up window instructions will change stating to trim to the trailer point and press the "+" button when ready.

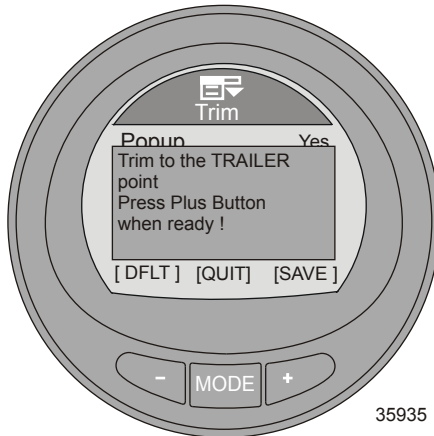

16. Press the "+" button to return to the "Calibration" option.
17. Press the "-" button to highlight the "Exit" option. Press the "MODE" button to return to the "Settings" menu.

## SETTINGS

18. Press the "-" button to highlight the "Exit" option. Press the "MODE" button to return to the "Main Menu" screen.

### Setting the Tanks

There are two tanks available for each power package installed on the vessel. Tank number "1" can be designated as not installed ("Not inst") or fuel. When "Not inst" is selected, the options for setting the tank capacity and the calibration cannot be edited. The maximum fuel capacity is 2271 liter (600 US gal). The second tank can be designated as not installed ("Not inst"), water, fuel, or waste on four-stroke engines and will automatically default to oil if the gauge is installed on a vessel with a two-stroke engine.

Two different methods are available to calibrate the tanks: For linear shaped fuel tanks, choose "Default Calibration." "Default Calibration" assumes the tank is uniformly shaped and that each quarter of the tank holds a quarter of its total capacity. Water and waste tanks are typical to this linear shape tank and are automatically set to the "Default Calibration." For irregularly shaped fuel tanks, choose "Add Fuel Method." Fuel must be added to the tank for each quarter of the capacity when using this method. The "Add Fuel Method" should be performed in the water for an accurate representation of the tank capacity.

***NOTE:*** Tank capacity must be calibrated by either the "Default Calibration," or "Add Fuel Method," or the capacity will revert back to its former value.

### TANK 1

1. While in the "Main Menu," press the "-" or "+" button to highlight the "Settings" menu.

# SETTINGS

2. Press the "MODE" button to enter the "Settings" menu.

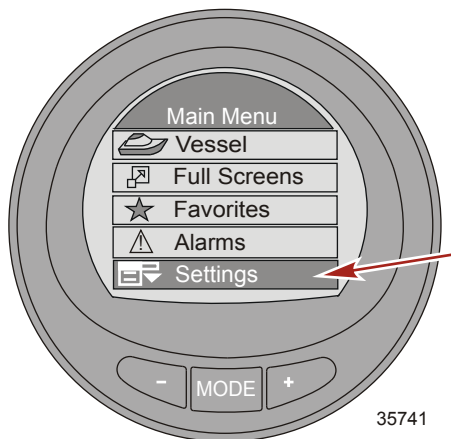

3. Press the "-" button to highlight the "Tanks" menu.
4. Press the "MODE" button to edit the "Tanks" menu.

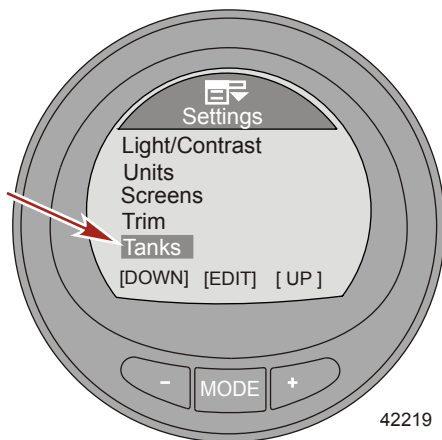

5. Press the "MODE" button to edit the "Tank 1 Type" option.

# SETTINGS

6. Press the "-" or "+" button to change the tank setting.

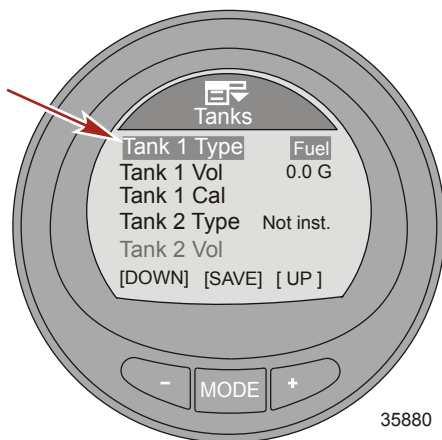

7. Press the "MODE" button to exit the "Tank 1 Type" option.

8. Press the "-" button to highlight the "Tank 1 Vol" capacity.

9. Press the "MODE" button to edit the capacity.

**NOTE:** The maximum capacity is 2271 liter (600 US gal).

10. Press the "-" or "+" button to change the capacity of the tank.  
Holding the button down will scroll through the numbers.

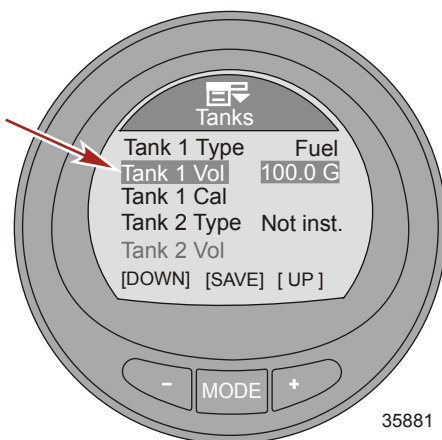

11. Press the "MODE" button to exit the "Tank 1 Vol" option.

# SETTINGS

12. Press the "-" button to highlight the "Tank 1 Cal" option.

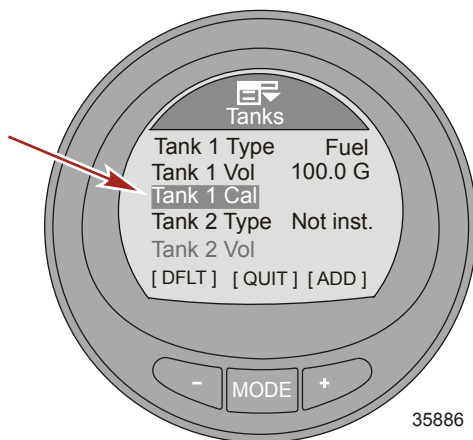

13. Press the "MODE" button to select the type of calibration.

**NOTE:** Two different methods are available to calibrate the tanks: For linear shaped fuel tanks, choose "Default Calibration." "Default Calibration" assumes the tank is uniformly shaped and that each quarter of the tank holds a quarter of its total capacity. Water and waste tanks are typical to this linear shape tank. For irregularly shaped fuel tanks, choose "Add Fuel Method." Fuel must be added to the tank for each quarter of the capacity when using this method. The "Add Fuel Method" should be performed in the water for an accurate representation of the tank capacity.

**NOTE:** The following procedure is used for the "Default Calibration" method.

# SETTINGS

14. Press the "-" button to choose the "Default Calibration" method or press the "MODE" button to quit the calibration.

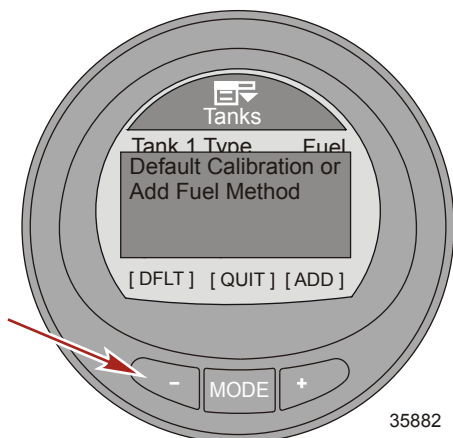

15. Press the "MODE" button to finish "(OK)" and exit the "Tank 1 Cal" option.

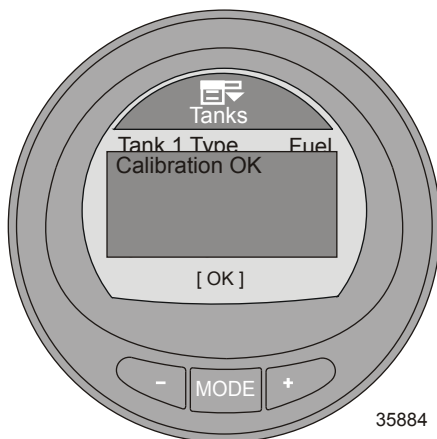

**NOTE:** The following procedure is used for the "Add Fuel Method" of calibration.

# SETTINGS

16. Press the "+" button to choose the "Add Fuel Method" or press the "MODE" button to quit the calibration.

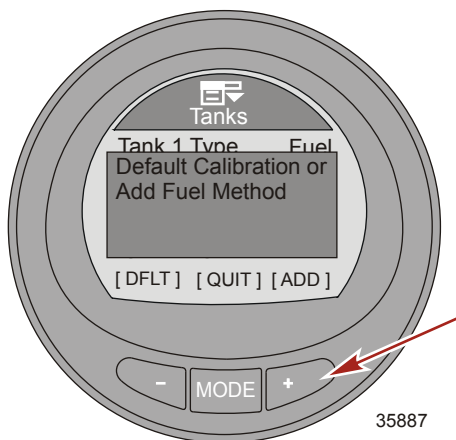

17. Press the "+" button to save and edit the "Add Fuel Method" of calibration.

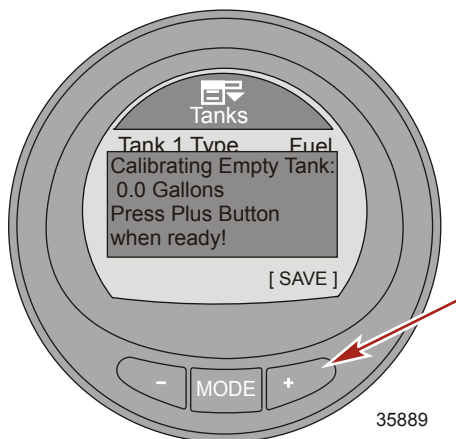

# SETTINGS

18. Add 25 percent of the fuel capacity to the empty fuel tank. The gauge will list the quantity of fuel to add for each quarter. Press the "+" button to save the calibration.

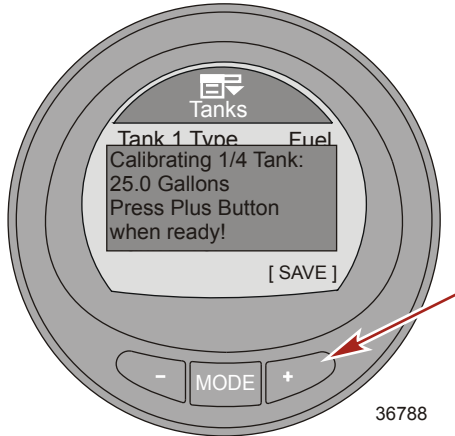

19. The fuel level sensor must change a minimal value when adding fuel. If the fuel level sensor does not change to the minimal value any time during the add fuel calibration, an error message stating the calibration is defaulting to values ("Error! Defaulting to values...") will be visible on the screen. The manual calibration process will stop when the error message appears. The fuel tank must be emptied and the manual calibration process must be repeated.

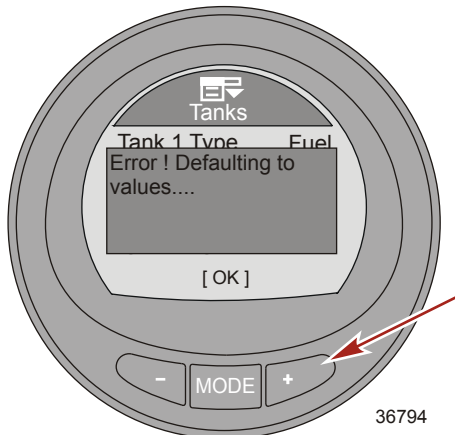



# SETTINGS

20. Add 25 percent more fuel capacity to the fuel tank. Press the "+" button to save the calibration.

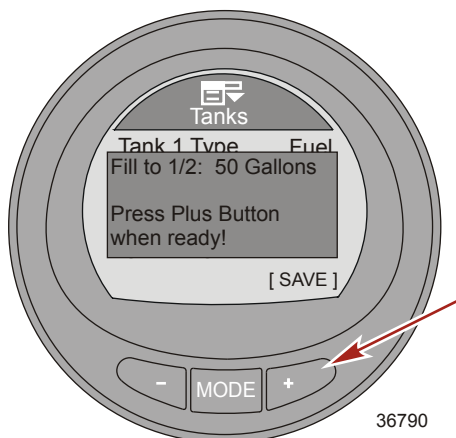

21. Add 25 percent more fuel capacity to the fuel tank. Press the "+" button to save the calibration.

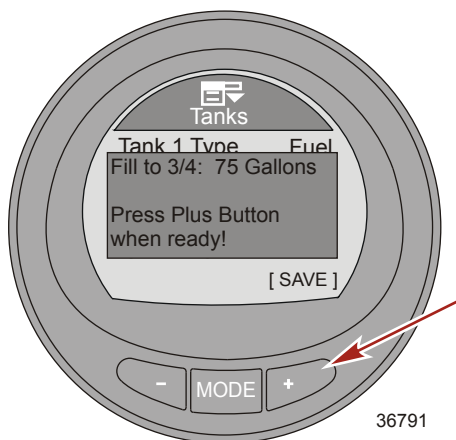

# SETTINGS

22. Add 25 percent more fuel capacity to fill the fuel tank. Press the "+" button to save the calibration.

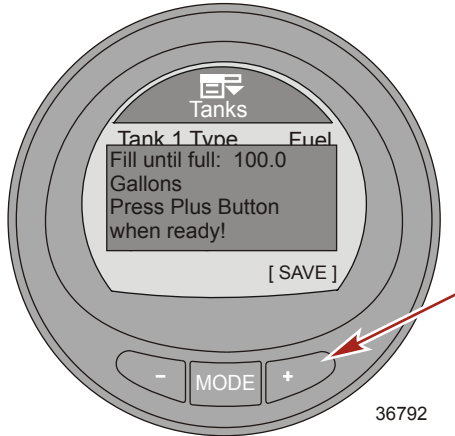

23. The screen on the monitor will state the fuel tank calibrations is successful ("Calibrations OK").

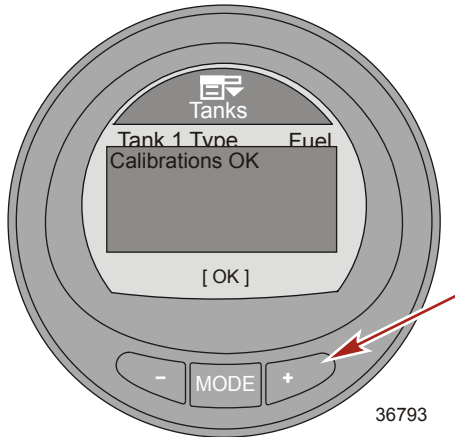

24. Press the "MODE" button to exit the calibration process.

25. Press the "-" button to edit the "Tank 2 Type" option.

# SETTINGS

## TANK 2

The second tank can be designated as not installed ("Not inst"), water, fuel, or waste when installed on a vessel with a four-stroke engine. The maximum fuel capacity is 2271 liter (600 US gal). When the tank is designated as water or waste, the calibration is automatically selected as default and will estimate the level based on a linear shape capacity and the calibration cannot be edited. When fuel is selected for tank 2, the calibration methods are the same as tank 1. Choose between the "Default Calibration" method or "Add Fuel Method."

When the gauge is installed on a vessel with a two-stroke engine, the second tank will default to oil automatically and cannot be calibrated.

## Setting the Alarms

Alarm settings can be customized to the vessel specifications and to the preference of the owner. Low fuel and critical fuel levels cannot be disabled, but can be adjusted to the preference of the owner. These levels can be adjusted down to 10 percent of the fuel tank volume. The shallow water depth, deep water depth, and waypoint distance alarms can be turned off or on. The shallow water depth alarm can be adjusted to 0.1 m (0.3 ft) and the deep water depth alarm can be adjusted to 300 m (984 ft). The pop-up alarm warning for these settings can be turned off or on. Vessels equipped with a generator or a heating, ventilation, air conditioning (HVAC) unit, can have these alarms turned off or on.

**NOTE:** HVAC currently has no validated manufacturers.

1. While in the "Main Menu," press the "-" or "+" button to highlight the "Settings" menu.

# SETTINGS

2. Press the "MODE" button to enter the "Settings" menu.

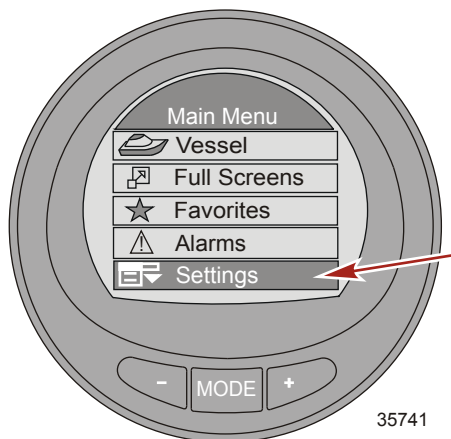

3. Press the "-" button to highlight the "Alarms" menu.
4. Press the "MODE" button to edit the "Alarms" menu.

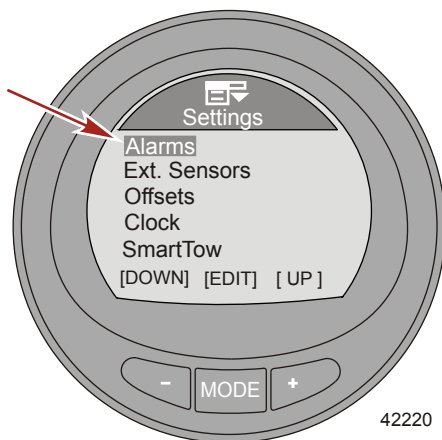

5. Press the "MODE" button to enter the "Fuel Critical" option.

# SETTINGS

6. Press the "-" or "+" to edit the "Fuel Critical" percentage. This percentage cannot be set lower than 10, or more than the "Fuel Low" alarm setting.

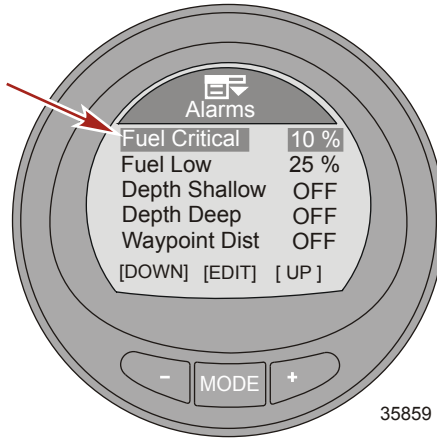

7. Press the "MODE" button to exit the "Fuel Critical" option.
8. Press the "-" button to highlight the "Fuel Low" option.
9. Press the "MODE" button to enter the "Fuel Low" option.
10. Press the "-" or "+" to edit the "Fuel Low" percentage. This percentage cannot be set lower than 10, or more than 50 percent.

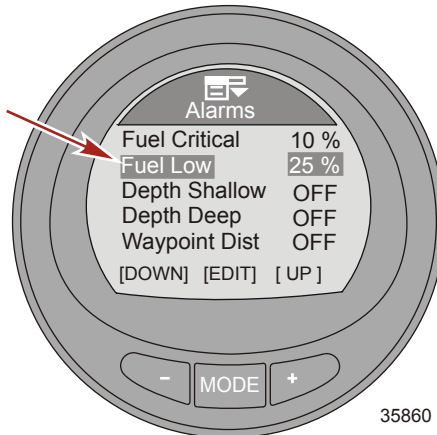

11. Press the "MODE" button to exit the "Fuel Low" option.
12. Press the "-" button to highlight the "Depth Shallow" option.

# SETTINGS

13. Press the "MODE" button to enter the "Depth Shallow" option.
14. Press the "-" or "+" to edit the "Depth Shallow" option. The minimum setting is 0.1 m (0.3 ft) and the maximum setting is 100 m (328 ft).

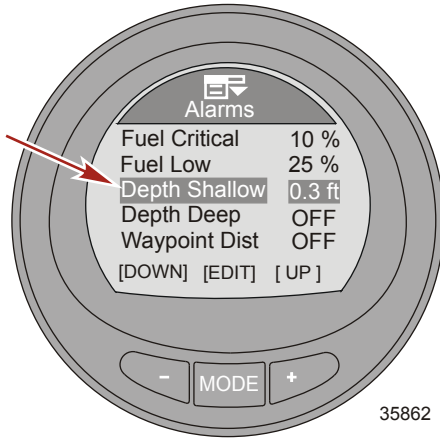

15. Press the "MODE" button to exit the "Depth Shallow" option.
16. Press the "-" button to highlight the "Depth Deep" option.
17. Press the "MODE" button to enter the "Depth Deep" option.
18. Press the "-" or "+" to edit the "Depth Deep" option. The minimum setting is 0.2 m (0.7 ft) and the maximum setting is 300 m (984 ft).

**NOTE:** The minimum setting can be set to 0.1 m (0.3 ft) when the "Depth Shallow" is set to "OFF."

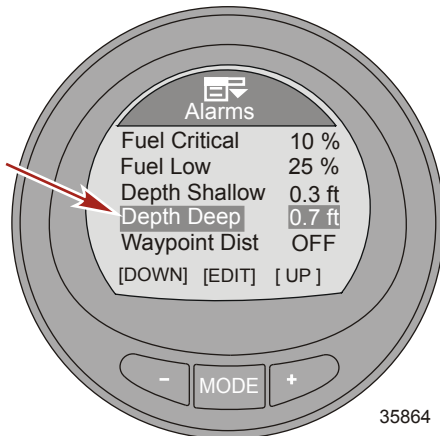

## SETTINGS

19. Press the "MODE" button to exit the "Depth Deep" option.
20. Press the "-" button to highlight the "Waypoint Dist" option.
21. Press the "MODE" button to enter the "Waypoint Dist" option.
22. Press the "-" or "+" to edit the "Waypoint Dist" option. The minimum setting is 161 m (0.1 mile) and the maximum setting is 482 m (0.3 mile).

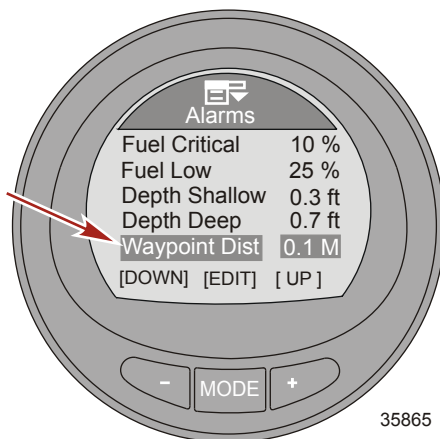

23. Press the "MODE" button to exit the "Waypoint Dist" option.
24. Press the "-" button to highlight the "Generator" option.

**NOTE:** A generator capable of sending data on the control area network (CAN) must be installed to edit this option.

# SETTINGS

25. Press the "MODE" button to turn the "Generator" option on ("Yes") or off ("No").

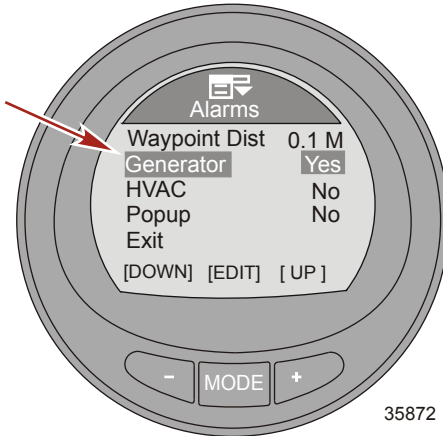

26. Press the "-" button to highlight the "HVAC" option.

**NOTE:** A HVAC unit capable of sending data on the control area network (CAN) must be installed to edit this option.

**NOTE:** HVAC currently has no validated manufacturers.

27. Press the "MODE" button to turn the "HVAC" option on ("Yes") or off ("No").

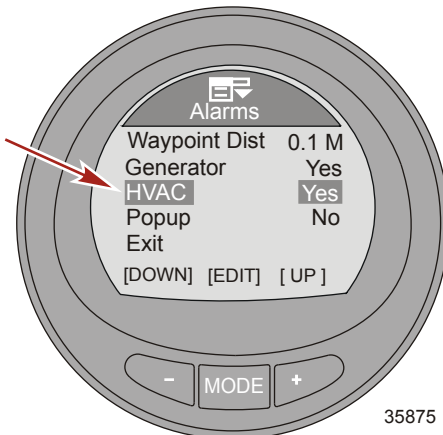

28. Press the "-" button to highlight the "Popup" option.



## SETTINGS

29. Press the "MODE" button to turn the "Popup" option on ("Yes") or off ("No").

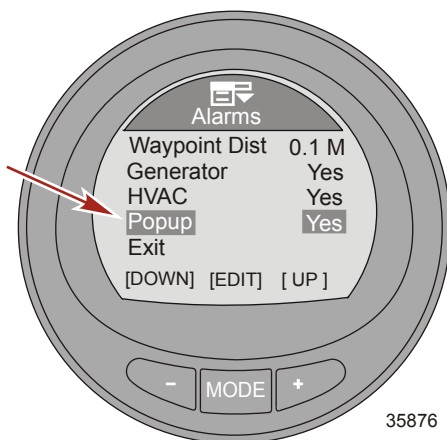

30. Press the "-" button to highlight the "Exit" option. Press the "MODE" button to exit the "Alarms" menu.

### Setting the External Sensors

The external sensors menu turns a number of sensors off or on. These include sea temperature, trim, GPS, speed, steering, and tabs. The external sensors menu also can change how the speed is recognized; pitot, paddle wheel, GPS, and at what speed the transition to a different sensor occurs. The type of pitot sensor can be changed from 689 kPa (100 psi) for most vessel applications, to a high speed 1379 kPa (200 psi) sensor. A high speed sensor must be installed for an accurate speed to be displayed when the 1379 kPa (200 psi) is selected.

1. While in the "Main Menu," press the "-" or "+" button to highlight the "Settings" menu.

# SETTINGS

2. Press the "MODE" button to enter the "Settings" menu.

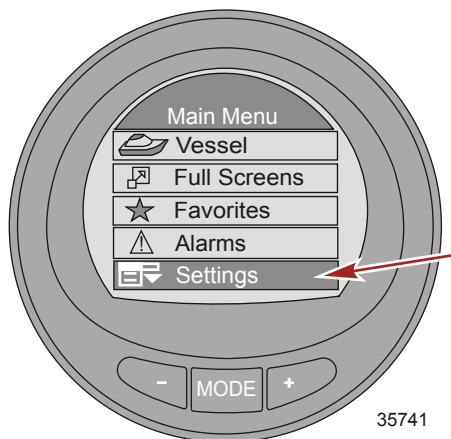

3. Press the "-" button to highlight the "Ext. Sensors" menu.
4. Press the "MODE" button to edit the "Ext. Sensors" menu.

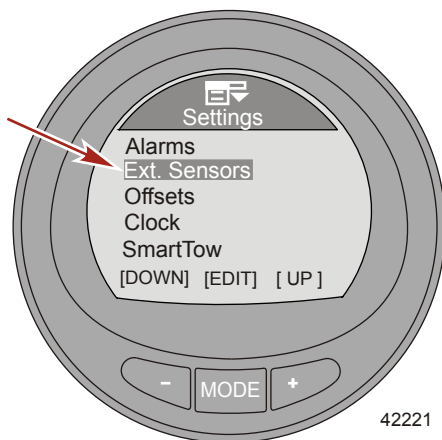

# SETTINGS

5. Press the "MODE" button to turn the "Depth/Seatemp" option on ("Yes") or off ("No").

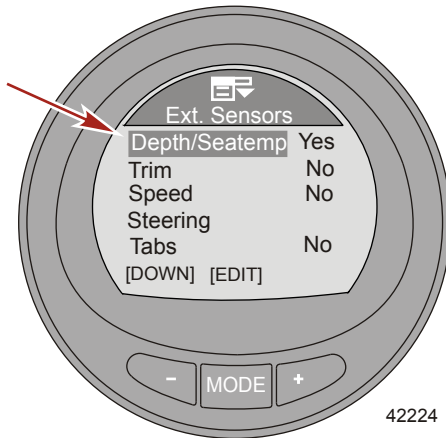

6. Press the "-" button to highlight the "Trim" option.
7. Press the "MODE" button to turn the "Trim" option on ("Yes") or off ("No").

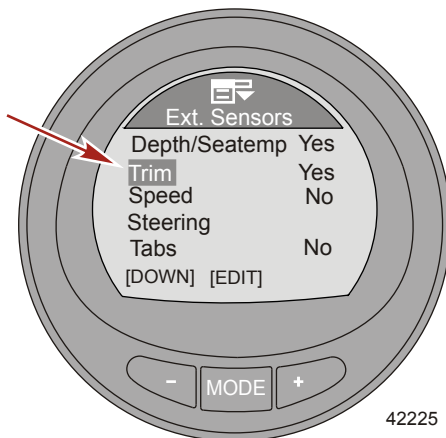

8. Press the "-" button to highlight the "Speed" option.

# SETTINGS

9. Press the "MODE" button to edit the "Speed" options.

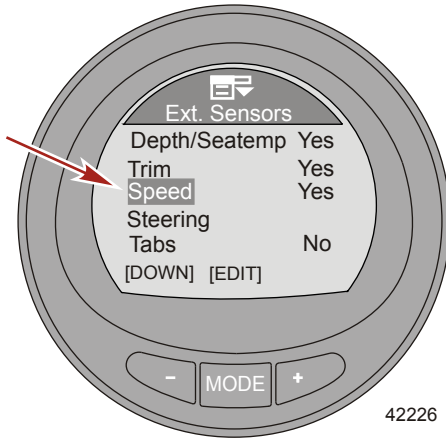

10. Press the "MODE" button to turn the "Use Paddle" option on ("Yes") or off ("No").

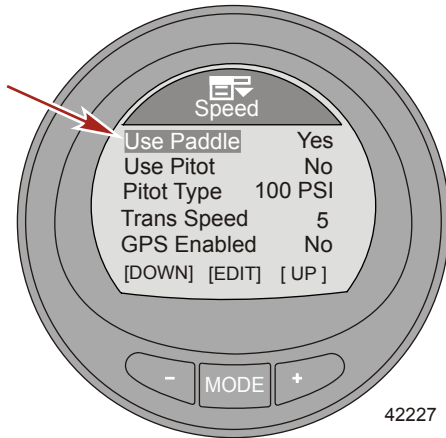

11. Press the "-" button to highlight the "Use Pitot" option.

# SETTINGS

12. Press the "MODE" button to turn the "Use Pitot" option on ("Yes") or off ("No").

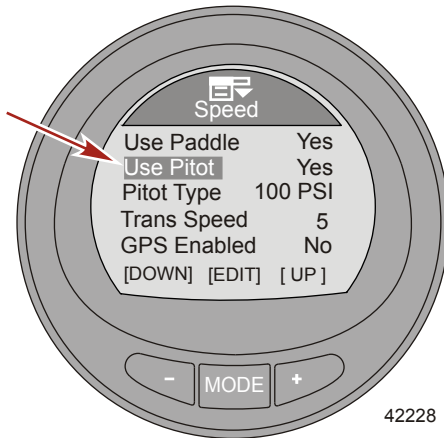

13. Press the "-" button to highlight the "Pitot Type" option.  
14. Press the "MODE" button to change the sensor to "100 PSI" or "200 PSI."

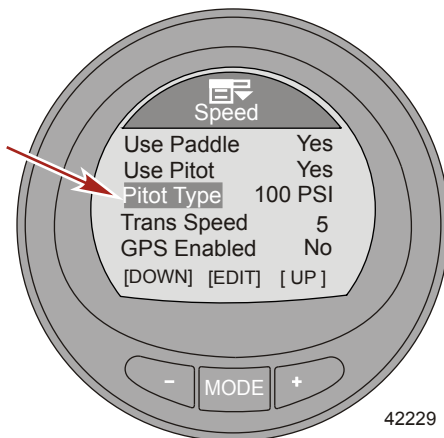

15. Press the "-" button to highlight the "Trans Speed" option.  
16. Press the "MODE" button to edit the "Trans Speed" option.

# SETTINGS

17. Press the "-" or "+" button to change the speed where the paddle wheel sensor transitions to the pitot or GPS. The transition speed can be changed from 8 km/h (5 mph) to 56 km/h (35 mph). Press the "MODE" button to exit the "Trans Speed" edit mode.

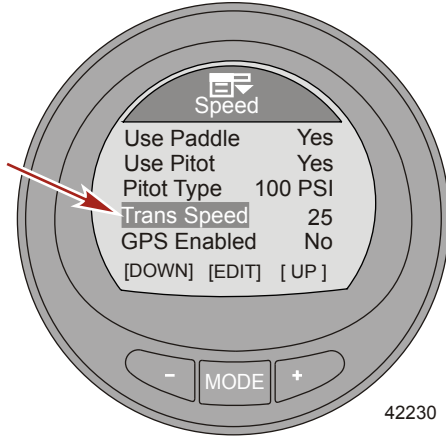

18. Press the "-" to highlight the "GPS Enabled" option.
19. Press the "MODE" button to turn the "GPS Enabled" option on ("Yes") or off ("No").

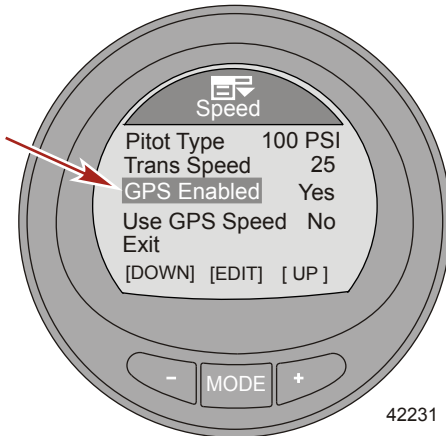

20. Press the "-" button to highlight the "Use GPS Speed" option.

## SETTINGS

21. Press the "MODE" button to turn the "Use GPS Speed" option on ("Yes") or off ("No").

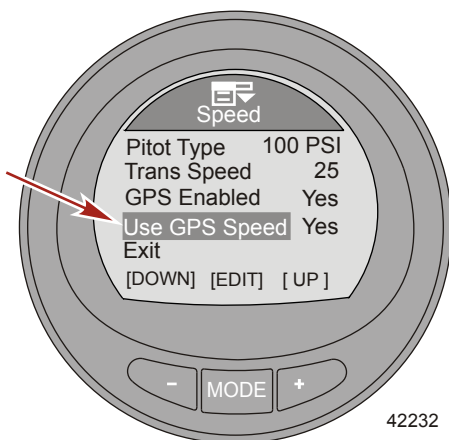

22. Press the "-" button to highlight the "Exit" option. Press the "MODE" button to exit the "Speed" menu.

### Setting the Offsets

The "Offsets" menu allows for compensation for inaccurate sensors, sets a transition speed from one speed sensor to another, inverts a steering sensor, and corrects the amount of fuel used. Sensors that can be modified are; sea temperature, depth, paddle wheel hertz, pitot pressure, and steering position.

1. While in the "Main Menu," press the "-" or "+" button to highlight the "Settings" menu.

# SETTINGS

2. Press the "MODE" button to enter the "Settings" menu.

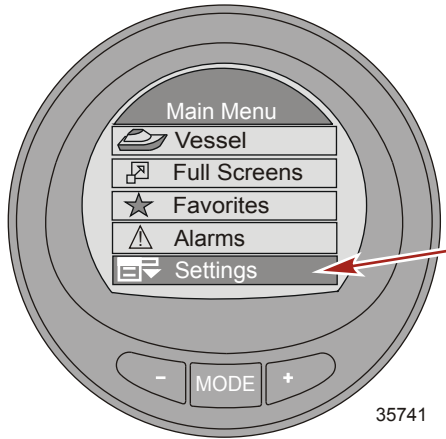

3. Press the "-" button to highlight the "Offsets" menu.
4. Press the "MODE" button to edit the "Offsets" menu.

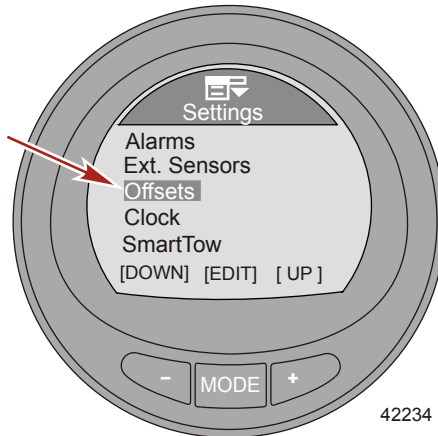

5. Press the "MODE" button to edit the "Seatemp" option.



# SETTINGS

6. Press the "-" or "+" button to change the sea temperature correction from -23.3 to -12.2 °C (-10 to 10 °F).

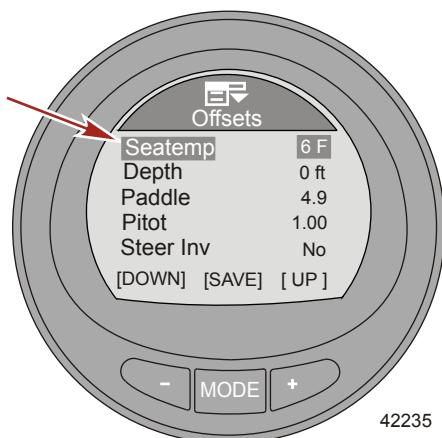

7. Press the "MODE" button to exit the "Seatemp" option.
8. Press the "-" button to highlight the "Depth" option.
9. Press the "MODE" button to edit the "Depth" option. The depth offset can be changed  $\pm 30.5$  m (100 ft).
10. Press the "-" or "+" button to change the depth offset.

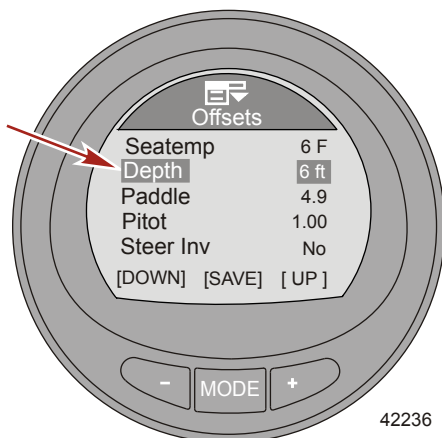

11. Press the "MODE" button to exit the "Depth" option.
12. Press the "-" button to highlight the "Paddle" option.
13. Press the "MODE" button to edit the "Paddle" option.

# SETTINGS

14. Press the "-" or "+" button to change the paddle offset. The offset can be changed from 3.4 Hz to 6.4 Hz.

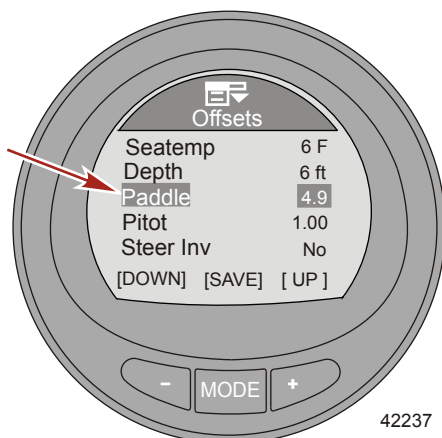

15. Press the "MODE" button to exit the "Paddle" option.  
16. Press the "-" button to highlight the "Pitot" option.  
17. Press the "MODE" button to edit the "Pitot" option.  
18. Press the "-" or "+" button to change the pitot offset. The offset can be changed from 0.50 to 1.50.

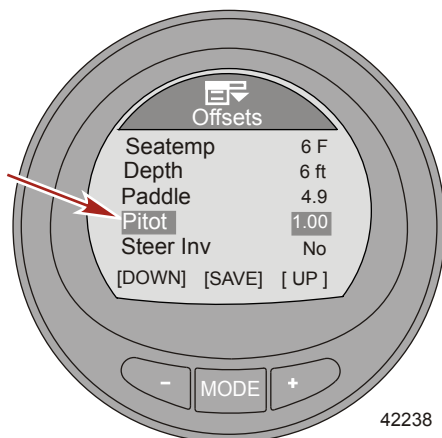

19. Press the "MODE" button to exit the "Pitot" option.  
20. Press the "-" button to highlight the "Steer Inv" option.

# SETTINGS

21. Press the "MODE" button to turn the "Steer Inv" option on ("Yes") or off ("No").

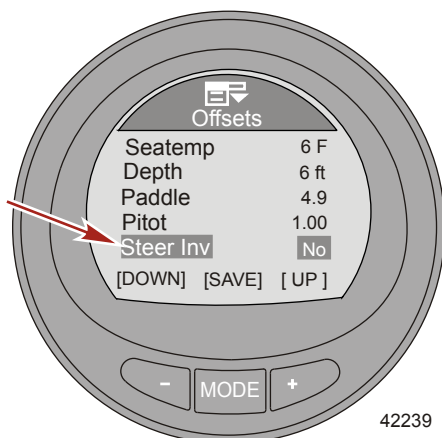

22. Press the "MODE" button to exit the "Steer Inv" option.  
23. Press the "-" button to highlight the "Steering" option.  
24. Press the "MODE" button to edit the "Steering" option.  
25. Press the "-" or "+" button to change the steering offset. The offset can be changed  $\pm 30$  degrees.

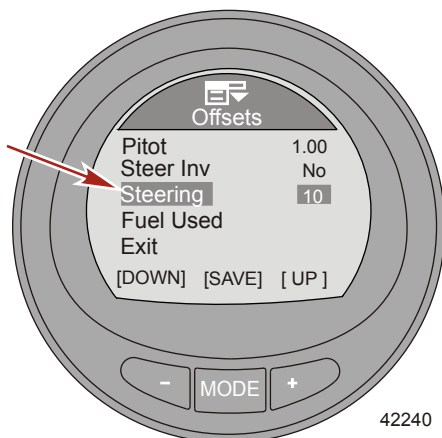

26. Press the "MODE" button to exit the "Steering" option.  
27. Press the "-" button to highlight the "Fuel Used" option.

# SETTINGS

28. Press the "MODE" button to edit the "Fuel Used" option.

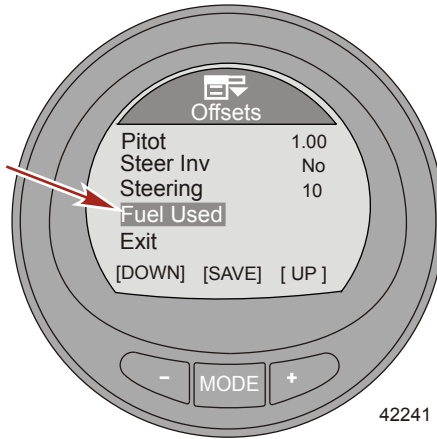

29. Press the "MODE" button to edit the "Multiplier" option.

30. Press the "-" or "+" button to change the multiplier offset. The offset can be changed from 0.50 to 1.50.

**NOTE:** The "Multiplier" is used to fine-tune the fuel gauge sender to correct for fuel used errors. If the gauge indicates that 10 gallons of fuel was used, but the actual fuel that was added is 14 gallons, change the multiplier to 1.40. If the gauge indicates that 10 gallons of fuel was used, but the actual fuel that was added is only 8 gallons, change the multiplier to 0.80.

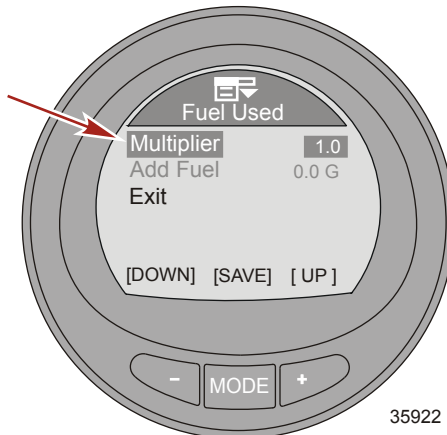

31. Press the "MODE" button to exit the "Multiplier" option.

## SETTINGS

32. Press the "-" button to highlight the "Add Fuel" option.
33. Press the "-" or "+" button to change the amount of fuel that was actually added to the fuel tank to correct for fuel capacity errors.  
***NOTE:** The "Add Fuel" option functions the same as the multiplier. If the gauge indicates that 10 gallons of fuel was used, but the actual fuel that was added is 14 gallons, change the "Add Fuel" to 14.0. If the gauge indicates that 10 gallons of fuel was used, but the actual fuel that was added is only 8 gallons, change the "Add Fuel" to 8.0 gallons. The gauge will calculate the multiplier and will automatically change the number in the "Multiplier" option.*
34. Press the "-" button to highlight the "Exit" option. Press the "MODE" button to exit the "Fuel Used" option.
35. Press the "-" button to highlight the "Exit" option. Press the "MODE" button to exit the "Offsets" menu.

### Setting the Clock

The "Clock" can be set to display a 24 hour day or a 12 hour (AM, PM) day. It can also be updated automatically when using a GPS. The GPS must be turned on ("Yes") in the external sensors ("Ext. Sensors") menu for the GPS menus to be enabled. The clock setting must have the "GPS Update" turned on ("Yes") for the universal time coordinated (UTC) to function. The UTC can be offset from -13 hours to +13 hours.

1. While in the "Main Menu," press the "-" or "+" button to highlight the "Settings" menu.

# SETTINGS

2. Press the "MODE" button to enter the "Settings" menu.

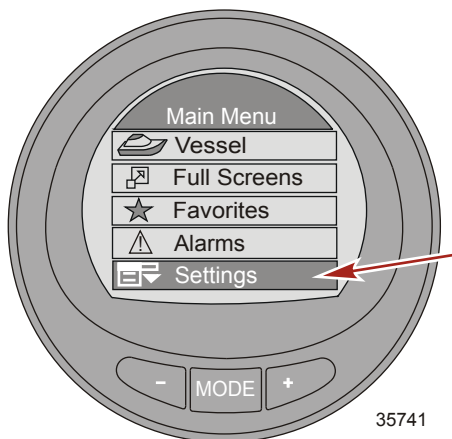

3. Press the "-" button to highlight the "Clock" menu.

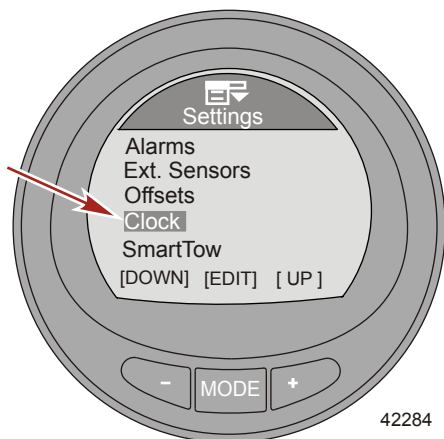

4. Press the "MODE" button to edit the "Clock" menu.

# SETTINGS

5. Press the "MODE" button to change the "Clock Format" option to 12 hour ("12h"), or 24 hour ("24h").

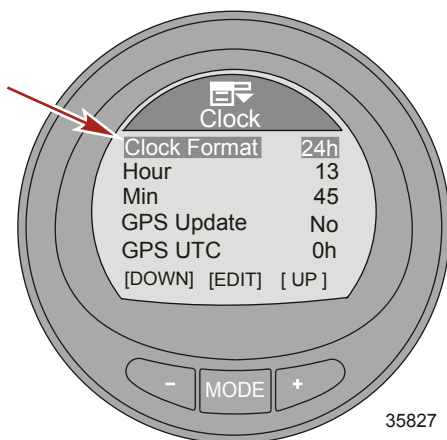

6. Press the "-" button to highlight the "Hour" option.
7. Press the "MODE" button to edit the "Hour" option.
8. Press the "-" or "+" button to edit the hour time.

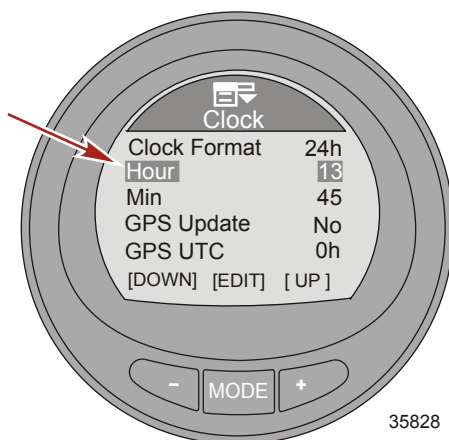

9. Press the "Mode" button to exit the hour edit mode.
10. Press the "-" button to highlight the "Min" option.
11. Press the "MODE" button to edit the "Min" option.

# SETTINGS

12. Press the "-" or "+" button to edit the minutes time.

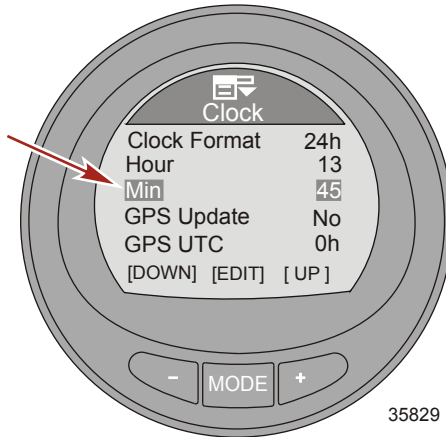

13. Press the "Mode" button to exit the minutes edit mode.

**NOTE:** A GPS must be connected to the monitor for the "GPS Update" to function, set waypoints, display GPS speed, UTC time, latitude, and longitude. A SmartCraft GPS puck must be installed to use the GPS speed based cruise control. If a GPS is not available, press the "-" button to highlight the "Exit" option. Press the "MODE" button to exit the clock menu.

14. Press the "-" button to highlight the "GPS Update" option.

15. Press the "MODE" button to change the "GPS Update" option to on ("Yes") or off ("No").

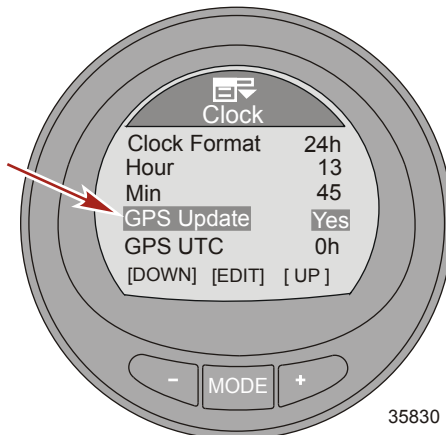



## SETTINGS

16. Press the "-" button to highlight the "GPS UTC" option.
17. Press the "MODE" button to edit the "GPS UTC" option.
18. Press the "-" or "+" button to edit the UTC offset time according to your vessel's location. The UTC can be offset from -13 hours to +13 hours.

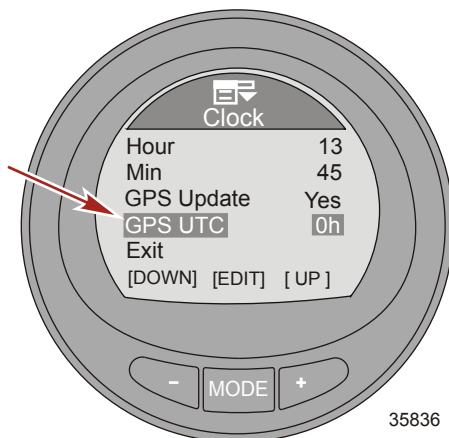

19. Press the "MODE" button to exit the "GPS UTC" option.
20. Press the "-" to highlight the "Exit" option and press the "MODE" button to exit the "Clock" menu.

## Smart Tow Settings

The "SmartTow" setting allows the user to select the type of speed sensor to use when Smart Tow is in use. "SmartTow" settings also allows the user to select the type of speed filter to use. Choose to turn the filter off, low, medium, or high. Choosing "OFF" has the most sensitivity and will maintain the vessel speed with less fluctuation in the actual speed. Use the filters if the paddle wheel speed is unstable causing unwanted engine RPM fluctuation. The "LOW" filter setting is the most responsive and will allow more actual speed fluctuation than when the filter is turned "OFF." The "HIGH" filter setting is the least responsive and will allow the most speed fluctuation and will slow the rate at which the speed changes.

1. While in the "Main Menu," press the "-" or "+" button to highlight the "Settings" menu.

# SETTINGS

2. Press the "MODE" button to enter the "Settings" menu.

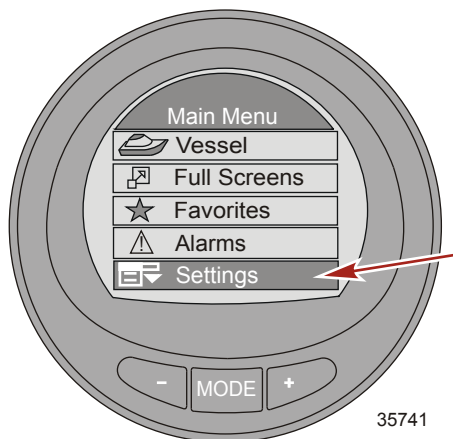

3. Press the "-" button to highlight the "SmartTow" menu.
4. Press the "MODE" button to enter the "SmartTow" menu.

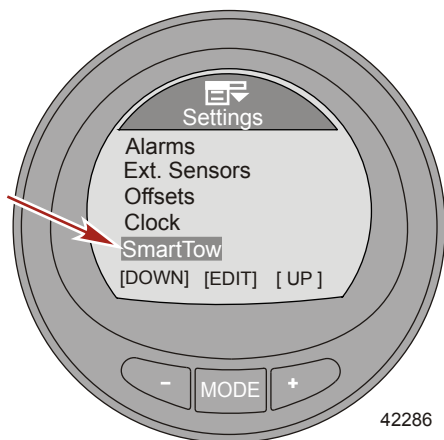

# SETTINGS

5. Press the "MODE" button to change the Smart Tow "Speed Input" option to paddle wheel ("Paddle") or to global position satellite "GPS."

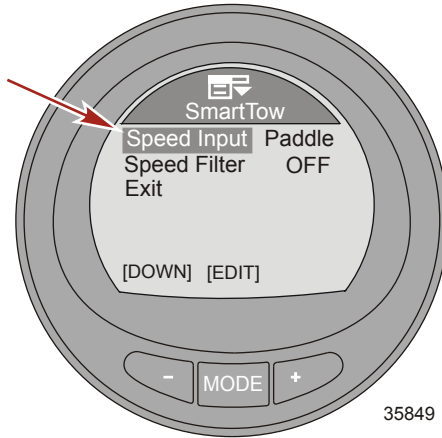

6. Press the "-" button to highlight the "Speed Filter" option.
7. Press the "MODE" button to change the filter to "OFF," "LOW," "MEDIUM," or "HIGH."

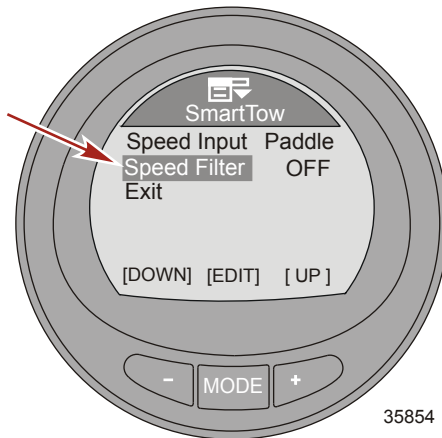

8. Press the "-" button to highlight the "Exit" option and press "MODE" to exit the "SmartTow" menu.

# SETTINGS

## Economy (ECO) Settings

The software for the ECO screen monitors the engine sensors and looks for the best fuel economy number while the vessel is in operation. When the software recognizes an improvement in the fuel economy, the gauge records what the trim and engine RPM values are at that time. This calculation happens whether the ECO screen is visible or not. When the software has recorded the RPM and trim values, it will guide the operator with arrows, to where that optimum running speed and trim setting was. **In most applications the ECO screen does not need any calibration**, although there are settings to customize the gauge for your boating style. The default settings are within acceptable parameters for most vessel applications.

**IMPORTANT: A manual trim calibration must be performed before the ECO screen can be used. Using a default trim calibration will not allow the ECO screen to function properly. The menu path is: "MAIN," > "Settings," > "Trim," > "Calibration."**

1. While in the "Main Menu," press the "-" or "+" button to highlight the "Settings" menu.
2. Press the "MODE" button to enter the "Settings" menu.

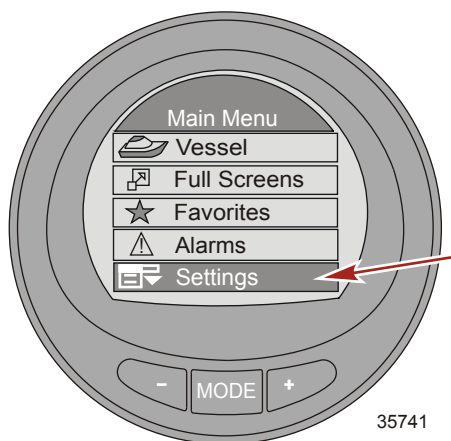

3. Press the "-" button to highlight the "ECO" menu.

# SETTINGS

**NOTE:** The default settings are within acceptable parameters for most vessel applications.

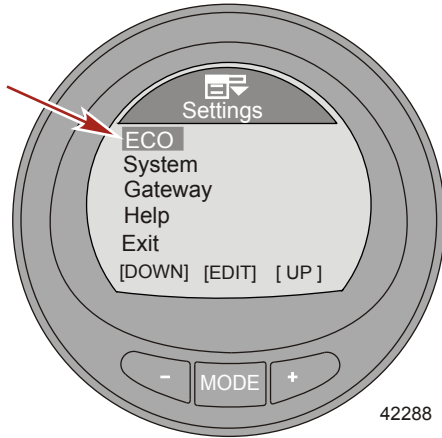

4. Press the "MODE" button to edit the "ECO" menu.
5. Press the "MODE" button to edit the "Min. RPM" option.
  - "Min. RPM" – Is used to customize the gauge for your boating style. This is the lowest RPM value the engine needs to achieve for the gauge to begin monitoring for the best fuel economy. The default setting is 2300 RPM.
6. Press the "-" or "+" button to change the minimum RPM.

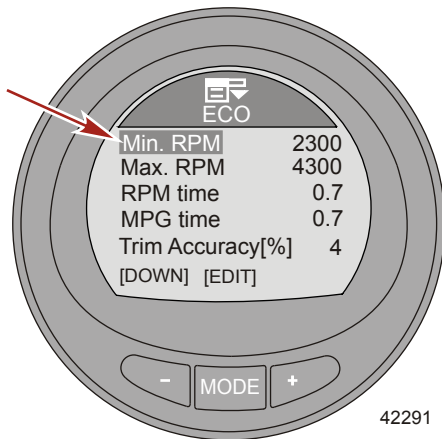

7. Press the "MODE" button to exit the "Min. RPM" edit option.

## SETTINGS

8. Press the "-" button to highlight the "Max. RPM" option.
9. Press the "MODE" button to edit the "Max. RPM" option.
  - "Max. RPM" – Is used to customize the gauge for your boating style. This is the highest RPM value the engine needs to achieve for the gauge to stop monitoring for the best fuel economy. The default setting is 4300 RPM.
10. Press the "-" or "+" button to change the maximum RPM.

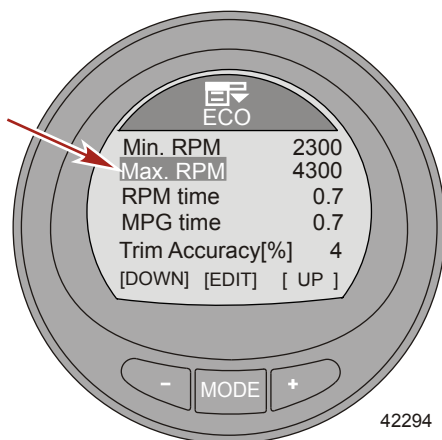

11. Press the "MODE" button to exit the "Max. RPM" edit option.
12. Press the "-" button to highlight the "RPM time" option.
13. Press the "MODE" button to edit the "RPM time" option.
  - "RPM time" – Is used to customize the gauge for your boating style. This is how much time (seconds) the RPM must remain consistent at the maximum fuel economy value before the gauge records the RPM and trim targets. The time ranges from 0.0–10.0 seconds. The default setting is 0.7.

# SETTINGS

14. Press the "-" or "+" button to change the "RPM time."

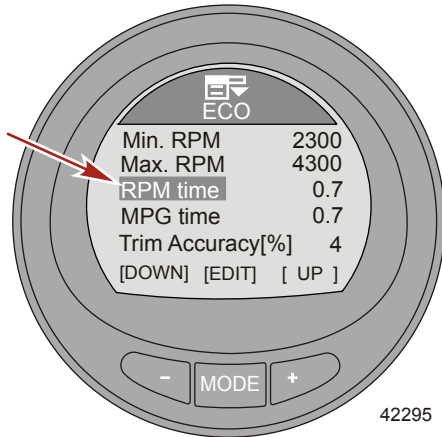

15. Press the "MODE" button to exit the "RPM time" edit option.

16. Press the "-" button to highlight the "MPG time" option.

17. Press the "MODE" button to edit the "MPG time" option.

- "MPG time" – Is used to customize the gauge for your boating style. This is how much time (seconds) the best fuel economy must remain consistent at the maximum value before the gauge records the RPM and trim targets. The time ranges from 0.0–10.0 seconds. The default setting is 0.7.

18. Press the "-" or "+" button to change the "MPG time."

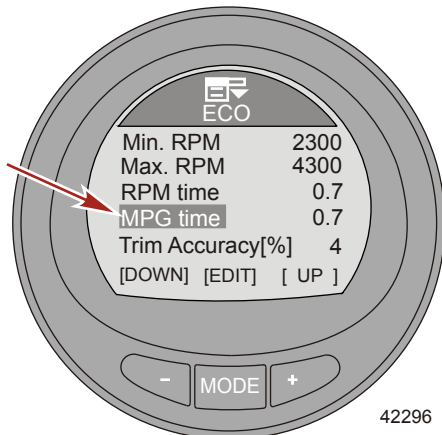

## SETTINGS

19. Press the "MODE" button to exit the "MPG time" edit option.
20. Press the "-" button to highlight the "Trim Accuracy [%]" option.
21. Press the "MODE" button to edit the "Trim Accuracy [%]" option.
  - "Trim Accuracy [%]" – Is used to customize the gauge for your boating style. This sets the size of the target window in the ECO screen for the trim position. The percentage ranges from 1–75; the larger the number, the larger the target window. The default setting is 4.
22. Press the "-" or "+" button to change the "Trim Accuracy [%]."

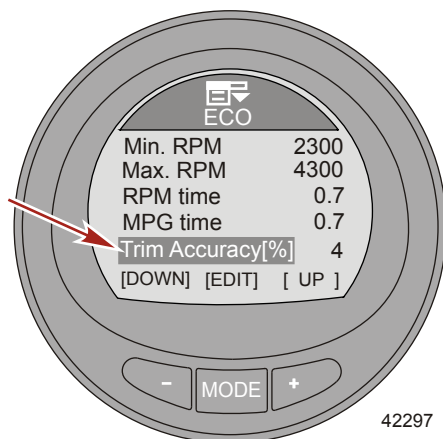

23. Press the "MODE" button to exit the "Trim Accuracy [%]" edit option.
24. Press the "-" button to highlight the "RPM Accuracy [%]" option.
25. Press the "MODE" button to edit the "RPM Accuracy [%]" option.
  - "RPM Accuracy [%]" – Is used to customize the gauge for your boating style. This sets the size of the target window in the ECO screen for the RPM. The percentage ranges from 1–75; the larger the number, the larger the target window. The default setting is 4.



# SETTINGS

26. Press the "-" or "+" button to change the "RPM Accuracy [%]." "

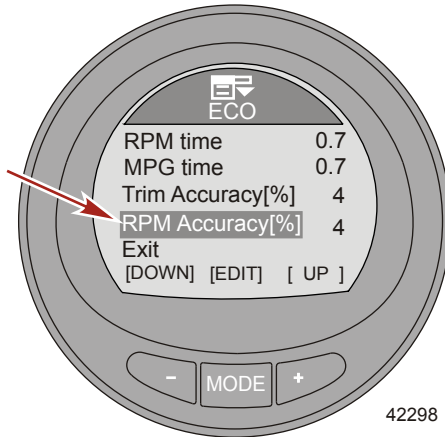

27. Press the "MODE" button to exit the "RPM Accuracy [%]" edit option.

28. Press the "-" button to highlight the "Exit" option. Press the "MODE" button to exit the "ECO" menu.

## Setting the System

### GAUGE IDENTIFICATION NAME

1. While in the "Main Menu," press the "-" or "+" button to highlight the "Settings" menu.
2. Press the "MODE" button to enter the "Settings" menu.

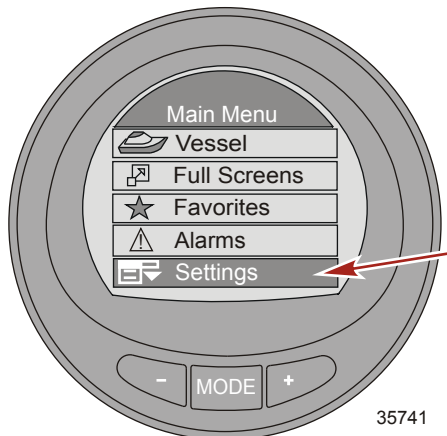

# SETTINGS

3. Press the "-" button to highlight the "System" menu.
4. Press the "MODE" button to edit the "System" menu.

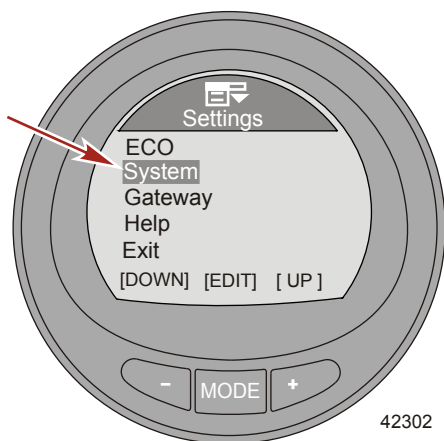

5. Press the "MODE" button to access the "Name" option. The name window will open up on the right side of the gauge.

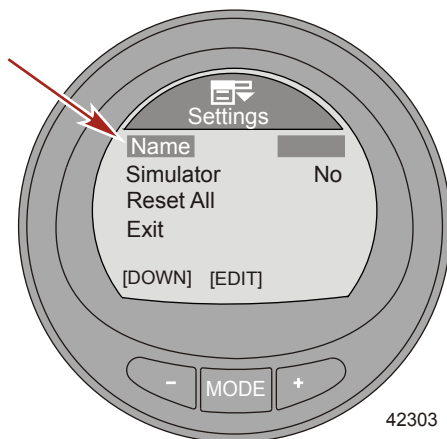

6. Press the "-" or "+" to choose the first letter of the gauge name. To save the letter and move to the next letter selection, press the "MODE" button.

# SETTINGS

**NOTE:** The gauge name can contain up to twelve characters. There is one empty character and 26 letter characters available. All twelve characters must be selected before exiting the "Name" option.

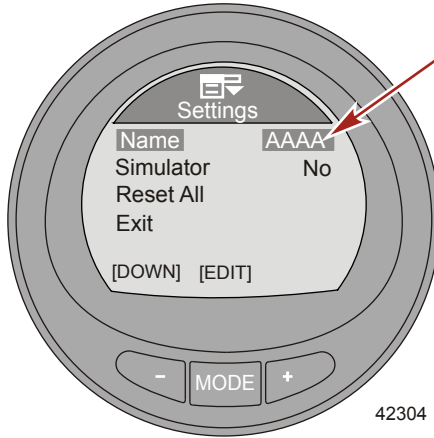

7. After the last character is saved, the name window is not active and the program returns to the "Name" option.
8. Press the "-" to highlight the "Exit" option and press "MODE" to return to the "Settings" menu.

**NOTE:** The "Simulator" option is available when the monitor is powered with a 12 volt source for display purpose only. This screen cannot be activated when connected to a power package.

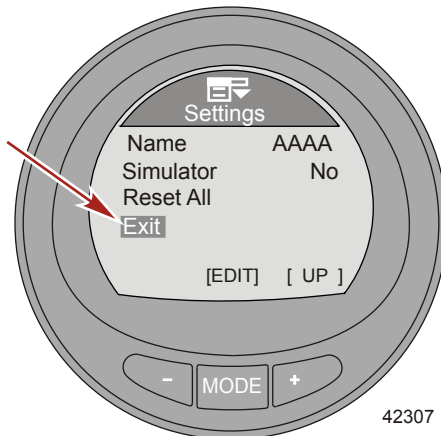

# SETTINGS

## Reset Gauge to the Factory Default Settings

**IMPORTANT:** Performing a reset will return the gauge to the factory defaults, eliminating any installation and calibrations performed during the set up of the product.

1. While in the "Main Menu," press the "-" or "+" button to highlight the "Settings" menu.
2. Press the "MODE" button to enter the "Settings" menu.

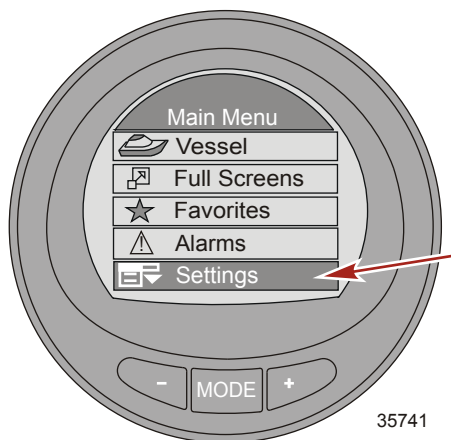

3. Press the "-" button to highlight the "System" menu.
4. Press the "MODE" button to edit the "System" menu.

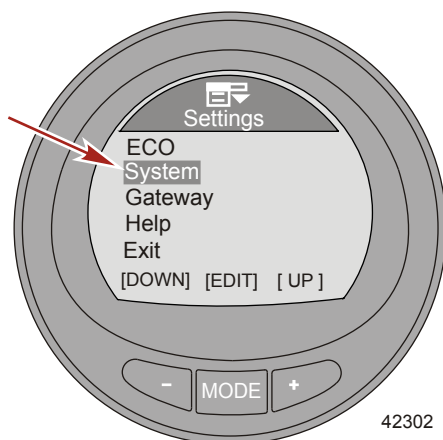

5. Press the "-" button to highlight the "Reset All" option.

# SETTINGS

6. Press the "MODE" button to edit the "Reset All" option.

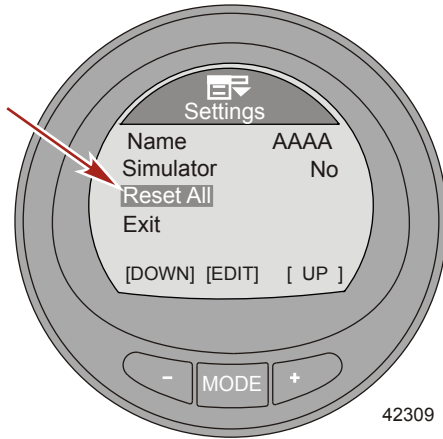

7. Press the "+" to reset the gauge to the factory default settings or press the "MODE" button to quit the reset function.

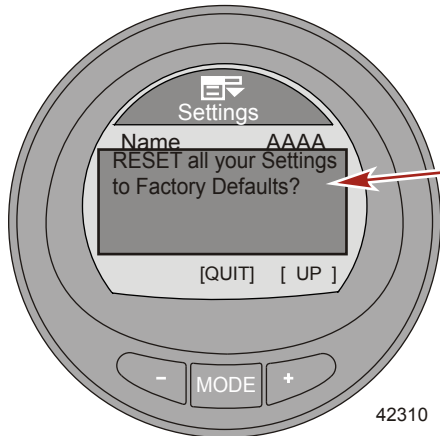

## Gateway Settings

Gateway is a software interface that allows or controls access to other programs through a NMEA 2000 or J1939 protocol; a channel for communication to share information. The software is capable of transmitting (**TX**) information to, and receiving (**RX**) information from various parameter group number (PGN) products.

# SETTINGS

1. While in the "Main Menu," press the "-" or "+" button to highlight the "Settings" menu.
2. Press the "MODE" button to enter the "Settings" menu.

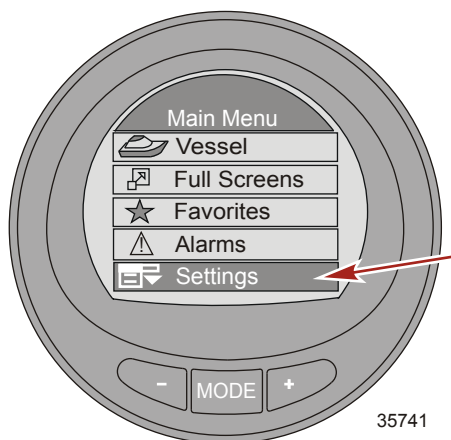

3. Press the "-" button to highlight the "Gateway" menu.
4. Press the "MODE" button to edit the "Gateway" menu.

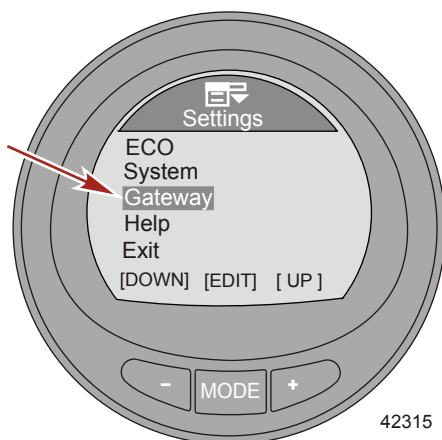

## SETTINGS

5. Press the "MODE" button to edit the "Gateway" option to "NMEA 2000," "J1939," or "OFF."

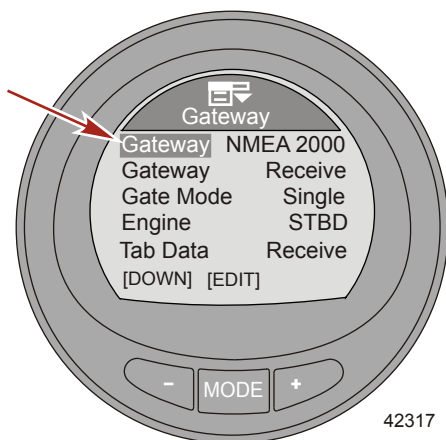

6. Press the "-" button to highlight the next "Gateway" menu.
7. Press the "MODE" button to edit the "Gateway" option to "Transmit" (TX) or "Receive" (RX).

**NOTE:** Only choose "Receive" when the monitor is used with an engine that is not SmartCraft compatible. The engine must be J1939 or NMEA 2000 compatible.

# SETTINGS

**IMPORTANT:** The use of the MercMonitor on non-SmartCraft engines, requires the MercMonitor gateway set to "Receive." Failure to set the gateway to "Receive" will cause numerous faults to appear that cannot be resolved. Changing the gateway to "Receive" will clear the faults. Refer to Section 1: General Information – MercMonitor Gateway Protocol Acceptance Description, to understand what data is available for non-SmartCraft engine applications.

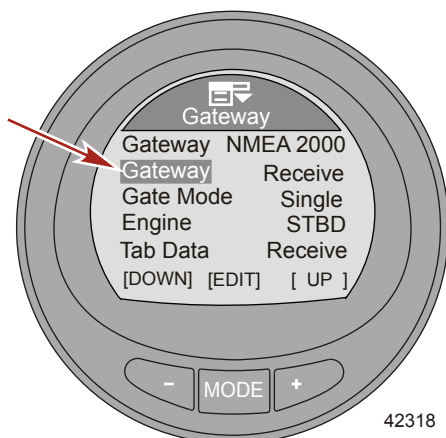

8. Press the "-" button to highlight the "Gate Mode" menu.
9. Press the "MODE" button to edit the "Gate Mode" option to "Single," "Dual," Triple," or "Quad" engine power package.



# SETTINGS

**NOTE:** Only the Gateway Premier MercMonitor can edit the "Gate Mode" option. All other MercMonitor models will default to "Single."

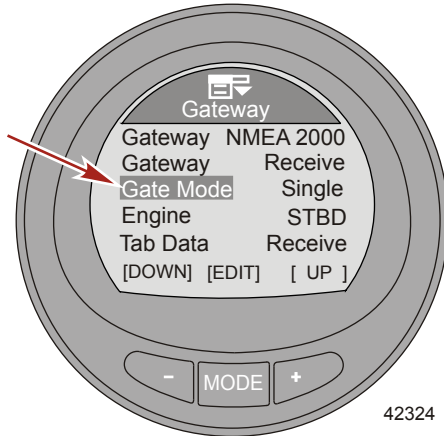

10. Press the "-" button to highlight the "Engine" menu.

11. Press the "MODE" button to edit the "Engine" option to starboard ("STBD"), port ("PORT"), starboard 2 ("STB2"), or port 2 ("PRT2").

**IMPORTANT:** This menu option assigns the gauge to a specific engine.

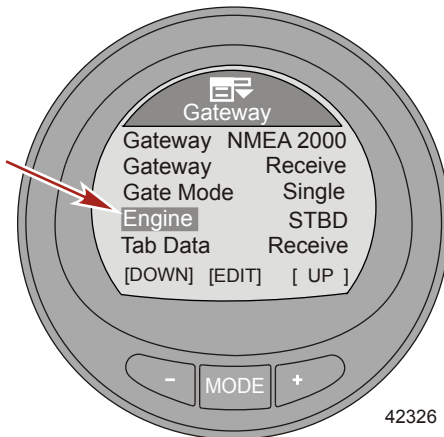

12. Press the "-" button to highlight the "Tab Data" menu.

# SETTINGS

13. Press the "MODE" button to edit the "Tab Data" option to "Transmit" (TX) or "Receive" (RX).

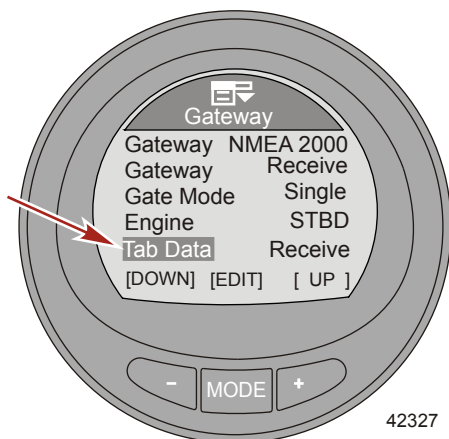

14. Press the "-" button to highlight the "Exit" option. Press the "MODE" button to return to the "Settings" menu.

## Help Menu

1. While in the "Main Menu," press the "-" or "+" button to highlight the "Settings" menu.
2. Press the "MODE" button to enter the "Settings" menu.

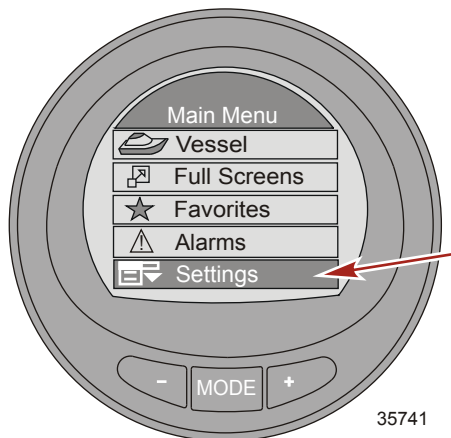

3. Press the "-" button to highlight the "Help" menu.

# SETTINGS

4. Press the "MODE" button to edit the "Help" menu.

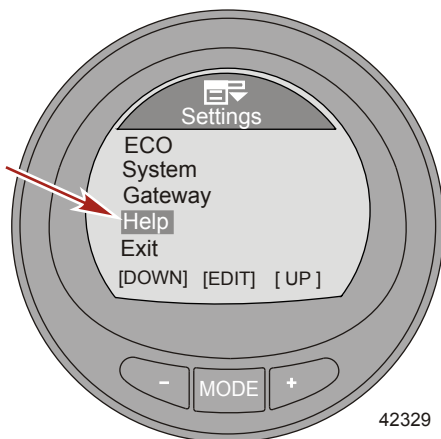

5. Press the "MODE" button to view how to select a screen to be displayed as a favorite.

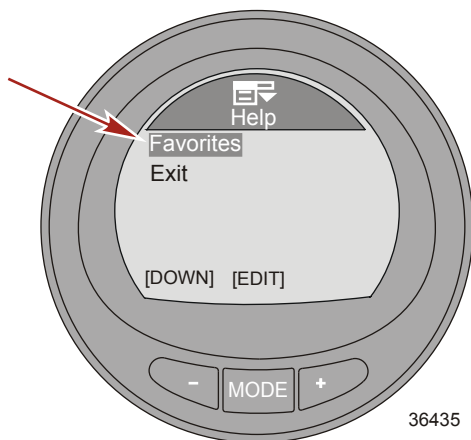

## SETTINGS

6. A window will pop-up stating to hold the "+" and "-" button down when the screen you desire to be part of the "Favorites" is visible on the monitor.

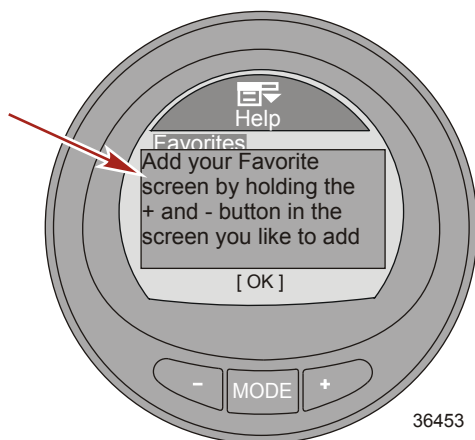

7. Press the "MODE" button to return to the main "Help" menu.
8. Press the "-" button to highlight the "Exit" option and press the "MODE" button to exit the "Help" menu.
9. Press the "-" button to highlight the "Exit" option and press the "MODE" button to exit the "Settings" menu.

# PROPULSION MENU

## Using Propulsion Screens

The "Propulsion" menu screens will display information about the boat propulsion systems. Screens that are available in the "Propulsion" menu may vary according to the engine type, but may include the following:

- Battery voltage
- RPM
- Water pressure
- Coolant temperature
- Oil temperature
- Oil pressure
- Peak speed
- Boost pressure
- Peak RPM
- Trim position
- Tab position
- Troll control
- Smart Tow

## Available Propulsion Screens

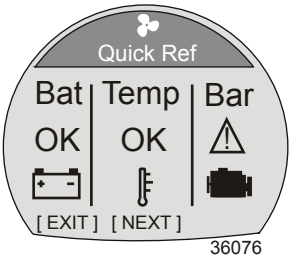
Quick Reference	The quick reference screen views current data on the battery state of charge, engine temperature, and oil pressure. When these items are within normal operating parameters, each reference will display "OK." When these items are not within normal operating parameters, a flashing triangle icon will appear.	 <p>The image shows a circular 'Quick Ref' screen divided into three vertical sections: 'Bat' (Battery), 'Temp' (Temperature), and 'Bar' (Pressure). Each section displays 'OK' and a corresponding icon: a battery symbol, a thermometer, and a pressure gauge. A flashing triangle warning icon is present in the 'Bar' section. At the bottom, there are '[EXIT]' and '[NEXT]' buttons. The number '36076' is in the bottom right corner.</p>
-----------------	---	---

# PROPULSION MENU

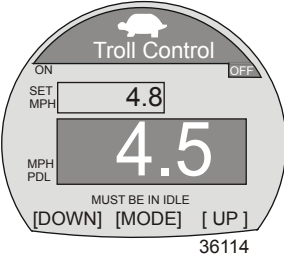
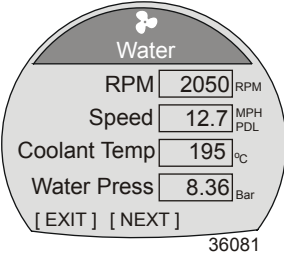
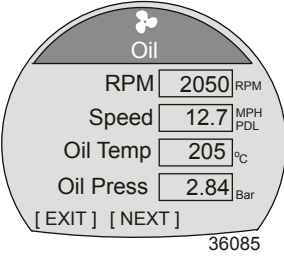
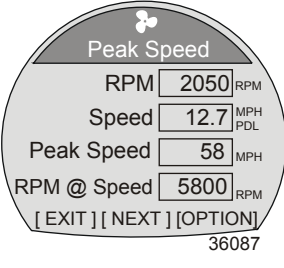
<p>Troll Control</p>	<p>Displays an icon to indicate the troll control is turned on or off. It can be controlled with the vessel speed through the active sensor or with the engine RPM.</p>	
<p>Water</p>	<p>Displays the engine RPM, vessel speed through the active sensor, coolant temperature, and water pressure.</p>	
<p>Oil</p>	<p>Displays the engine RPM, vessel speed through the active sensor, oil temperature, and oil pressure.</p>	
<p>Peak Speed</p>	<p>Displays the engine RPM, vessel speed through the active sensor, the peak vessel speed, and what the engine RPM was at that peak vessel speed. The peak values can be reset.</p>	

# PROPULSION MENU

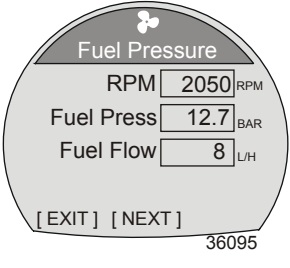
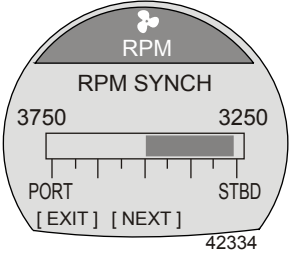
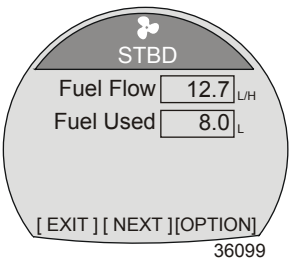
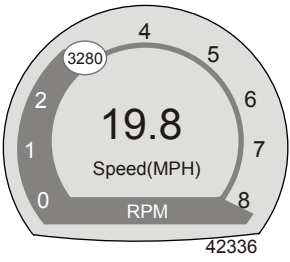
<p>Fuel Pressure</p>	<p>Displays the engine RPM, fuel pressure, and amount of fuel that is currently used per hour.</p>	
<p>RPM Synch</p>	<p>Displays the engine RPM and color band indicating to increase or decrease the RPM to synchronize the engines.</p>	
<p>Engine Location Fuel Use</p>	<p>Displays the engine location the gauge is connected to, the amount of fuel that is currently used per hour, and the amount of fuel that has been used. The amount of fuel used can be reset. STBD (starboard engine) PORT (port engine) CNTR (center engine) STB2 (starboard center) PRT2 (port center)</p>	
<p>Double Screens</p>	<p>The double screen displays two selected data options on an outer and inner display. The outer data will be displayed as a bar graph with a small window that moves with the bar graph leading edge. The inner data will be displayed as numbers. Options that can be selected are; "RPM," "Speed," "Coolant Temp," "Oil Temp," "Seatemp," "Water Press," "Oil Press," "Fuel Flow," "Fuel," "Battery," "Depth," "Temp 2."</p>	

# PROPULSION MENU

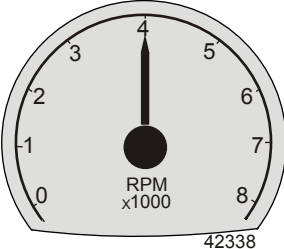
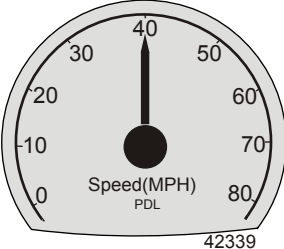
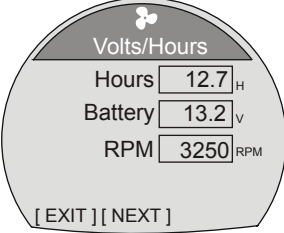
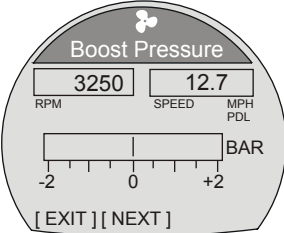
<p>Analog Tachometer</p>	<p>Displays the engine RPM with a sweeping pointer.</p>	 <p>42338</p>
<p>Analog Speedometer</p>	<p>Displays the vessel speed with a sweeping pointer. Two different ranges are available; 0–80 or 0–120 as knots, kilometers per hour, or miles per hour</p>	 <p>42339</p>
<p>Volts/Hours</p>	<p>Displays the total hours the engine has run, the battery current state of charge, and the engine RPM.</p>	 <p>36102</p>
<p>Boost Pressure</p>	<p>Displays the engine RPM, the vessel speed through the active sensor, and the amount of manifold pressure.</p>	 <p>36106</p>

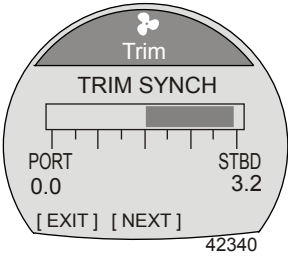
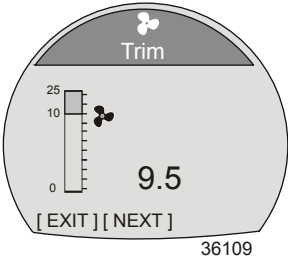
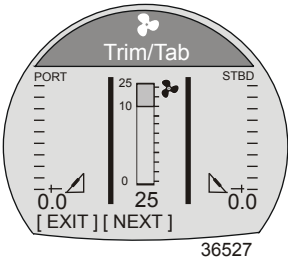
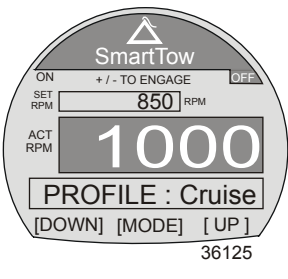

# PROPULSION MENU

<p>Trim Synch (Dual Engine)</p>	<p>Displays a color band indicating to increase or decrease the trim to synchronize the engines trim location.</p>	
<p>Trim</p>	<p>Displays the position of the trim with a moving propeller icon and displays the trim position number relative to the propeller icon.</p>	
<p>Trim/Tab</p>	<p>Displays the position of the port and starboard tabs with a moving tab icon and the trim position with a moving propeller icon. A number relative to the position of the icons is also displayed in the lower portion of the screen.</p>	
<p>Smart Tow</p>	<p>Displays an icon to indicate Smart Tow is turned on or off, selects cruise control or launch control, selects the launch control level from one to five, allows the creation of up to eight customized launch levels beyond launch level five, selects if Smart Tow is based on RPM or speed.</p>	

# PROPULSION MENU

## Troll Control Screen

The "Troll Control" screen displays an icon to indicate the troll control is turned on or off, the engine RPM, or the vessel speed. Troll control can be controlled by the vessel speed or the engine RPM.

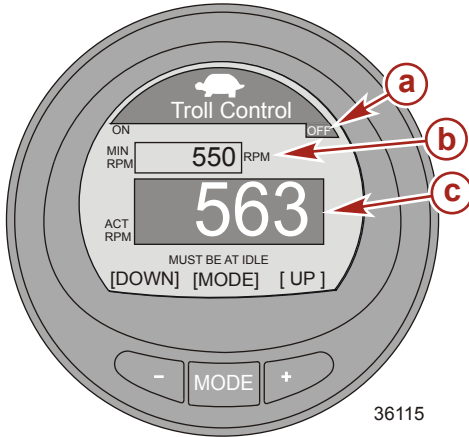

- a** - Icon indicating troll control is turned off
- b** - Set RPM
- c** - Actual engine RPM

## TURNING TROLL CONTROL ON AND OFF

1. Ensure the engine is running and the remote control is in gear at idle.
2. To turn the troll control on, press the "-" and "+" buttons at the same time. The troll control "ON" icon will be highlighted and the information below the RPM will change to "+/- TO DISENGAGE."

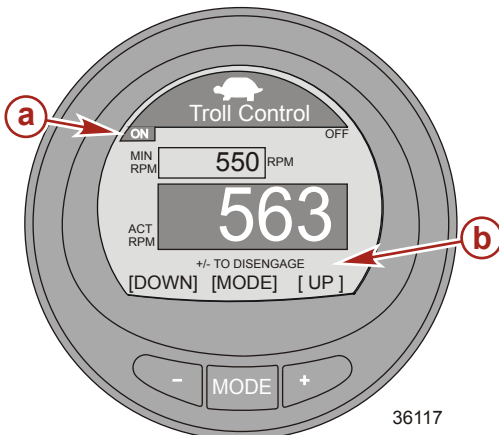

- a** - Troll control "ON" icon
- b** - "+/- TO DISENGAGE"

3. Press the "-" or "+" button to decrease or increase the engine RPM.

# PROPULSION MENU

**NOTE:** The minimum RPM and the maximum RPM will depend on the power package application.

4. To turn the troll control off, press the "-" and "+" buttons at the same time, or move the remote control handle into neutral. The troll control "OFF" icon will be highlighted and the information below the RPM will change to "+/- TO ENGAGE."

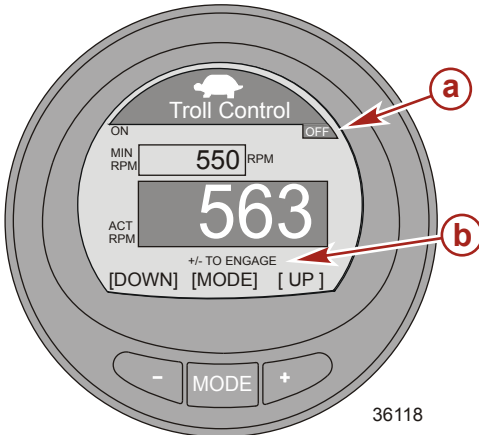

**a** - Troll control "OFF" icon

**b** - "+/- TO ENGAGE"

36118

## CHANGING THE TROLL CONTROL MODE OF CONTROL

The troll control function can be controlled with the engine RPM or the vessel speed. To use the vessel speed to control the troll function, a paddle wheel must be installed. Using the engine RPM to control the troll function will cause the vessel speed to vary based on the conditions the vessel encounters: wind, waves, or current. Using the vessel speed to control the troll function will cause the engine RPM to fluctuate more, based on the conditions the vessel encounters: wind, waves, or current. Changing the troll control mode can be done when the troll control is turned on or off.

# PROPULSION MENU

1. While the troll control screen is visible, press and hold the "MODE" button until the screen changes mode.

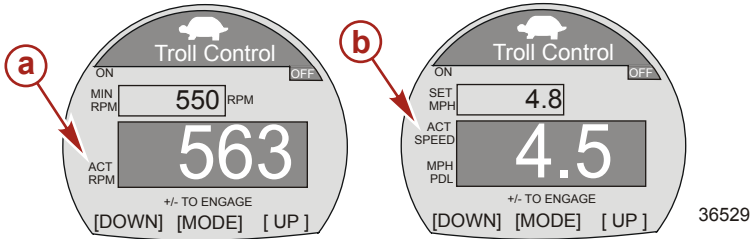

**a** - RPM mode

**b** - Speed mode

2. Press the "-" or "+" button to change the speed. The engine RPM will react to the selected speed when the troll control is engaged.
3. To change back to the RPM mode, press and hold the "MODE" button until the screen changes from speed mode to the RPM mode.
4. If there is no paddle wheel installed on the vessel, the speed mode of control will show text below the "ACT SPEED" window indicating a paddle wheel is required ("PADDLE REQUIRED").

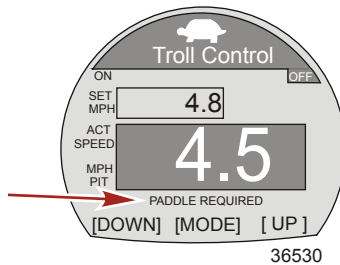

# PROPULSION MENU

## Water Screen

The "Water" screen displays the engine RPM, vessel speed through the active sensor, coolant temperature, and water pressure.

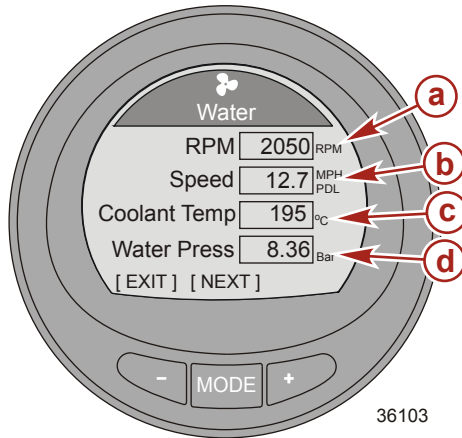

- a** - RPM
- b** - Vessel speed
- c** - Coolant temperature
- d** - Water pressure

## Oil Screen

The "Oil" screen displays the engine RPM, vessel speed through the active sensor, oil temperature, and oil pressure.

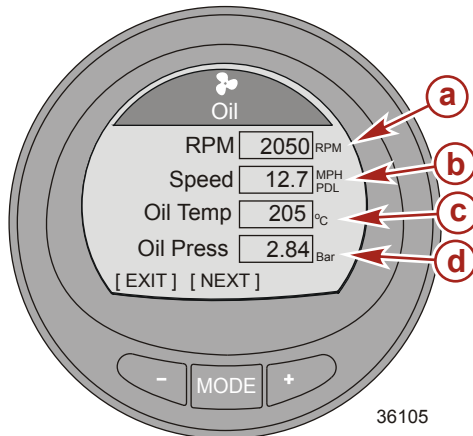

- a** - RPM
- b** - Vessel speed
- c** - Oil temperature
- d** - Oil pressure

# PROPULSION MENU

## Peak Speed Screen

The "Peak Speed" screen displays the engine RPM, vessel speed through the active sensor, the peak vessel speed, and what the engine RPM was at that peak vessel speed. The peak values information will automatically update when the recorded values are exceeded.

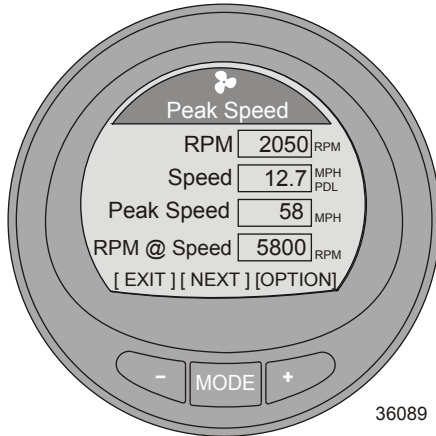

## RESET PEAK VALUES

The peak values can be reset to record new information.

1. Press the "+" button to open the option to reset the peak values.
2. Press the "-" ("YES") or "+" ("NO") to reset the peak values. The screen will return to the "Peak Speed" screen.

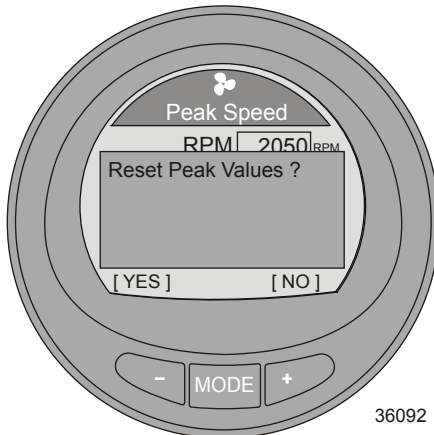

# PROPULSION MENU

## Fuel Pressure Screen

The "Fuel Pressure" screen displays the engine RPM, fuel pressure, and amount of fuel that is currently used per hour. The fuel flow is calculated by the PCM/ECM.

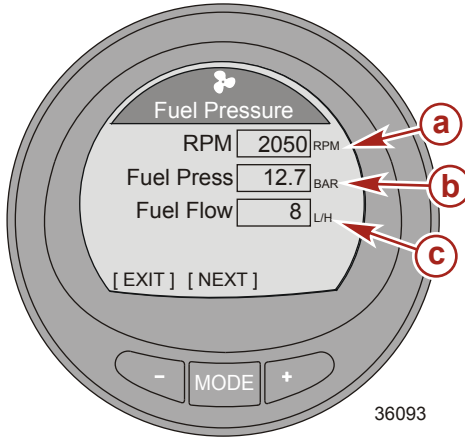

- a** - RPM
- b** - Fuel pressure
- c** - Fuel flow

36093

## RPM Synchronize Screen

The "RPM SYNCH" screen displays the engine RPM and a color band that expands under the engine with the lower RPM. The color band will decrease in size as the engine RPM's near synchronization.

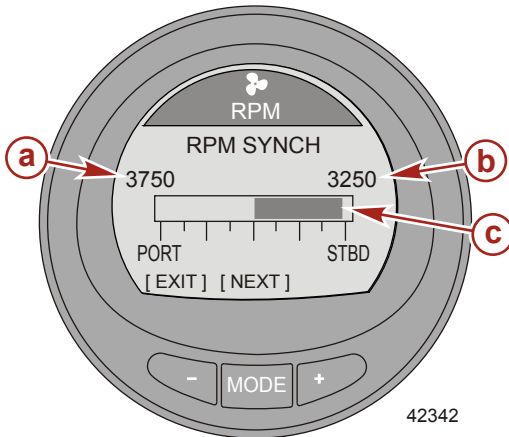

- a** - Port engine RPM
- b** - Starboard engine RPM
- c** - Color band indicating starboard engine RPM is low

42342

# PROPULSION MENU

## Engine Location Fuel Use

The engine location fuel use screen shows the engine location the gauge is connected to in the upper part of the screen, the amount of fuel that is currently used per hour, and the amount of fuel that has been used for that particular engine. The amount of fuel used can be reset.

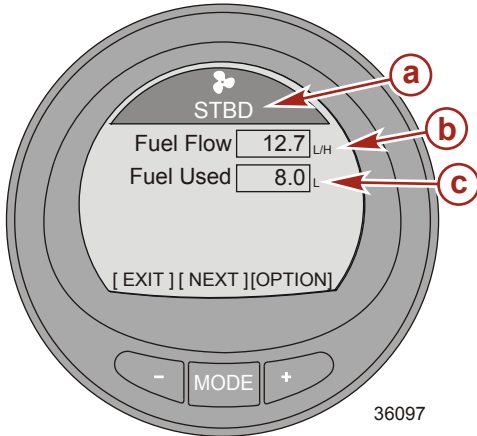

36097

- a** - Engine location gauge is connected to
- b** - Fuel flow
- c** - Fuel used

## FUEL USED RESET

1. Press the "+" button to open the "Fuel Used" reset option.
2. Press the "-" ("YES") button to reset the fuel used, or the "+" ("NO") button to return to the fuel use per engine location screen.

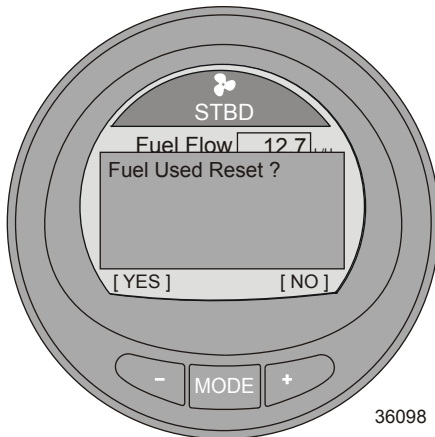

36098



# PROPULSION MENU

## Double Screens

The double screen displays two selected data options on an outer and inner display. The outer data will be displayed as a bar graph with a small window that moves with the bar graph leading edge. The inner data will be displayed as numbers. Options that can be selected are; "RPM," "Speed," "Coolant Temp," "Oil Temp," "Seatemp," "Water Press," "Oil Press," "Fuel Flow," "Fuel," "Battery," "Depth," "Temp 2." There are five double screens available.

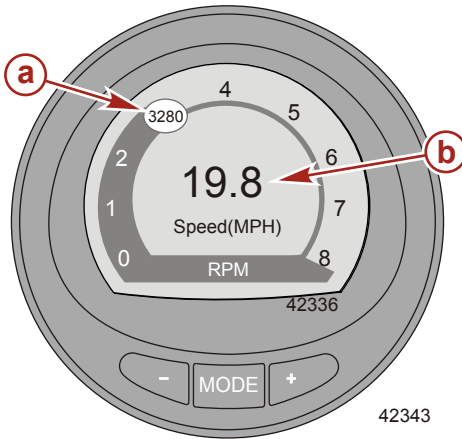

- a** - Moving window showing the engine RPM
- b** - Vessel speed

## Analog Tachometer Screen

The analog tachometer displays the engine RPM with a sweeping pointer, simulating a mechanical analog tachometer.

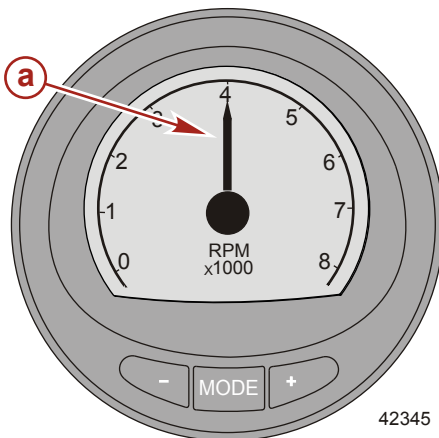

- a** - Sweeping pointer

# PROPULSION MENU

## Analog Speedometer Screen

The analog speedometer displays the vessel speed with a sweeping pointer, simulating a mechanical analog speedometer. Two speedometer scales are available; 0–80 and 0–120.

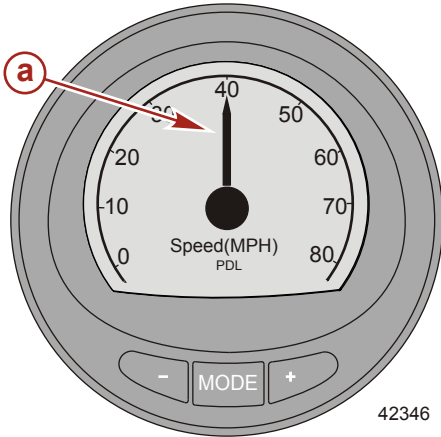

**a** - Sweeping pointer

42346

## Volts/Hours Screen

The "Volts/Hours" screen displays the total hours the engine has run, the battery current state of charge, and the engine RPM.

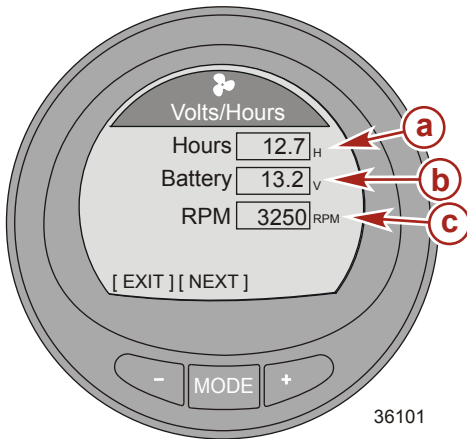

**a** - Total engine hours  
**b** - Battery state of charge  
**c** - RPM

36101

# PROPULSION MENU

## Boost Pressure Screen

The "Boost Pressure" screen displays the engine RPM, the vessel speed through the active sensor, and the amount of manifold pressure.

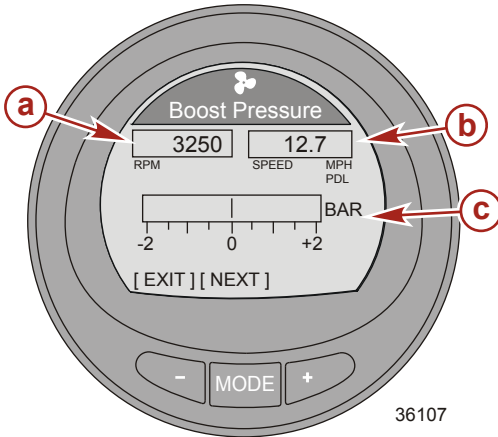

- a** - RPM
- b** - Vessel speed
- c** - Manifold pressure

## Trim Synchronize Screen

The "Trim Synch" screen displays a color band indicating to increase or decrease the trim to synchronize the engines trim location. The numbers are a point of reference, relating to the position of the trim outside of the synchronization.

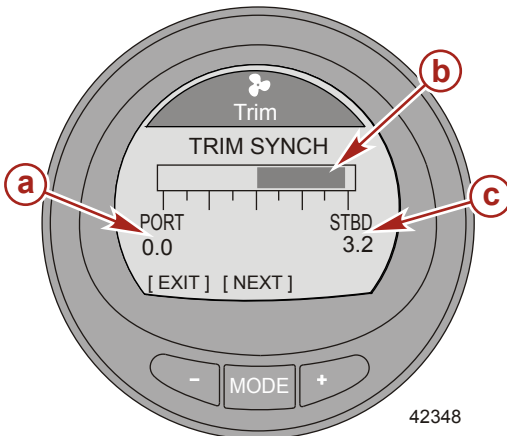

- a** - Port engine trim point of reference
- b** - Color band
- c** - Starboard engine trim point of reference

# PROPULSION MENU

## Trim/Tab Screen

The "Trim/Tab" screen displays the position of the port and starboard tabs with a moving icon that represents the relative position of the tabs. A number below the tab display will indicate the relative position of the tab. The center of the display will show the position of the trim with a moving icon that represents the relative position of the trim. A number below the trim display will indicate the relative position of the trim.

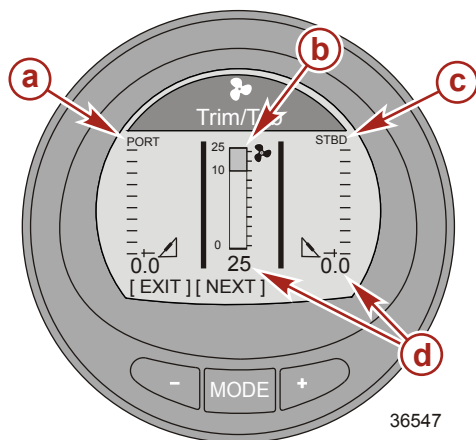

- a** - Port tab indicator
- b** - Trim indicator
- c** - Starboard tab indicator
- d** - Number indicating the relative position

## Smart Tow

### SMART TOW OPERATION

**NOTE:** Cruise and launch control is only available with Gen I (2007) and newer DTS engines.

**NOTE:** The cruise control minimum and maximum range will vary depending on the type of power package application.

# PROPULSION MENU

There are two modes of cruise control: RPM mode and speed mode. The launch control will inherit the mode of control selected. There are five launch levels. Level 1 is the most gradual and level 5 is the most aggressive. Beyond launch level 5 are eight customized launch settings. Each customized launch setting name can have up to seven characters to identify the custom launch. To use the speed setting control, a paddle wheel must be installed, or a SmartCraft GPS puck must be installed.

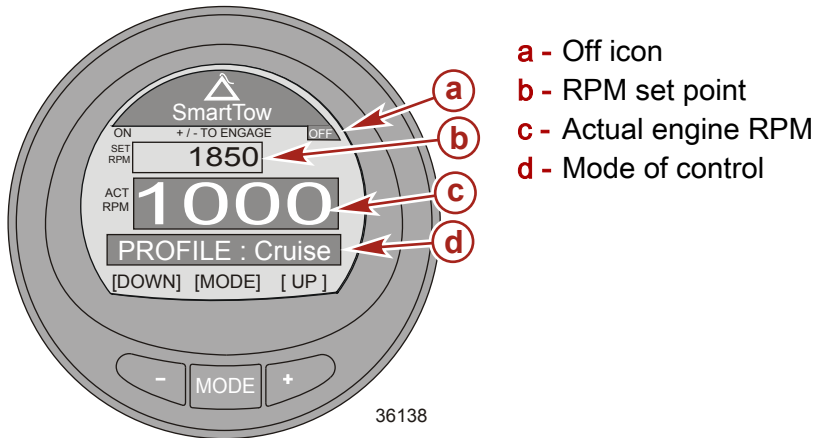

# PROPULSION MENU

1. To engage the "Smart Tow" function, press the "-" and "+" button at the same time. The Smart Tow "ON" icon will be highlighted in the upper left corner and the information above the "SET RPM" window will be changed to "+/- TO DISENGAGE." When Smart Tow is engaged, the "ON" icon will remain on and be visible on all of the monitor screens.

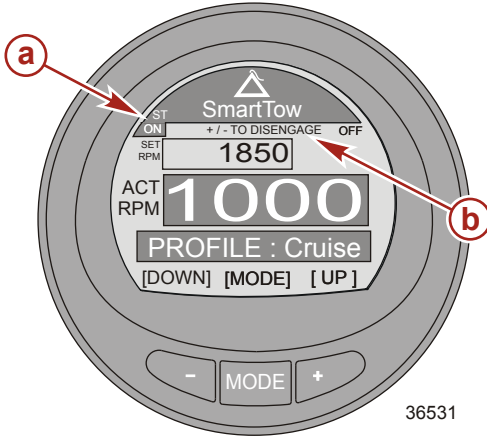

- a - "ON" icon
- b - "+/- TO DISENGAGE"

36531

2. Shift the drive unit into forward gear. The throttle must be above the set cruise RPM or speed for the Smart Tow cruise to function. When the throttle is moved below the set cruise engine RPM or speed, the engine RPM will decrease with the throttle movement.
3. Press the "-" button to decrease the engine RPM. Press the "+" button to increase the engine RPM.
4. To disengage the "Smart Tow" function, press the "-" and "+" button at the same time. The Smart Tow "OFF" icon will be highlighted in the upper right corner, and the information above the "SET RPM" window will change to "+/- TO ENGAGE."

# PROPULSION MENU

## Changing the Cruise Control Mode

There are two modes of cruise control: RPM mode and speed mode. To use the vessel speed to control the cruise function, a paddle wheel must be installed, or a SmartCraft GPS puck must be installed. Using the engine RPM to control the cruise function will cause the vessel speed to vary based on the conditions the vessel encounters: wind, waves, or current. Using the vessel speed to control the cruise function will cause the engine RPM to fluctuate more, based on the conditions the vessel encounters: wind, waves, or current. Changing the cruise control mode can be done when the troll control is turned on or off.

1. To change the mode of cruise control, press and hold the "MODE" button until the screen changes the mode of cruise control.

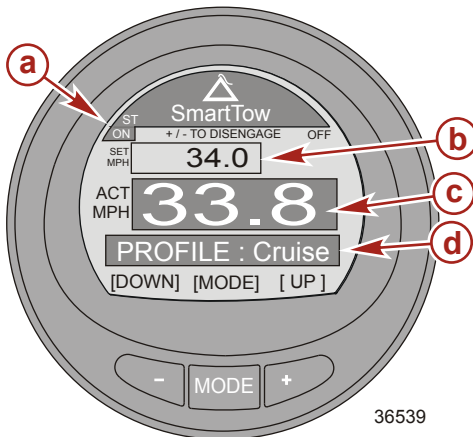

- a - "ON" icon
- b - RPM set point
- c - Actual engine RPM
- d - Mode of control

2. The operation of the cruise control in speed mode is the same as RPM mode. Shift the drive unit into forward gear. The throttle must be above the set cruise speed for the "Smart Tow" cruise to function. When the throttle is moved below the set cruise engine speed, the engine RPM will decrease with the throttle movement.
3. Press the "-" button to decrease the speed. Press the "+" button to increase the speed.
4. To disengage the "Smart Tow" function, press the "-" and "+" button at the same time. The Smart Tow "OFF" icon will be highlighted in the upper right corner and the information above the "SET MPH" window will change to "+/- TO ENGAGE."

# PROPULSION MENU

## Selecting a Launch Control

1. While the "Smart Tow" cruise screen is visible, press the "MODE" button and an icon of a person skiing will appear on the profile screen for approximately three seconds.

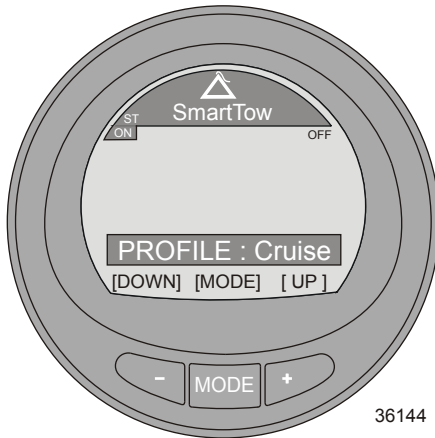

2. Press the "-" or "+" button when the profile screen is visible to advance through or change the launch modes, including all of the customized launch settings.

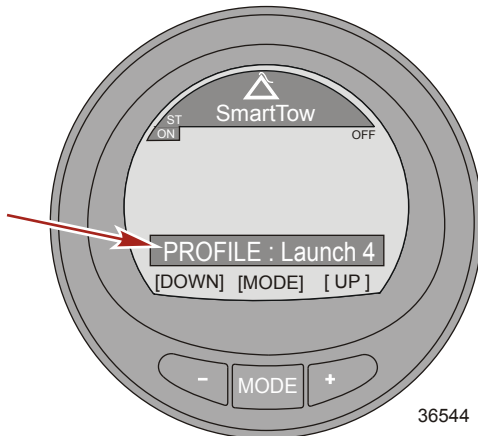



# PROPULSION MENU

3. After selecting the launch setting, the screen will return to the "Smart Tow" screen and the selected launch setting will populate the lower window.

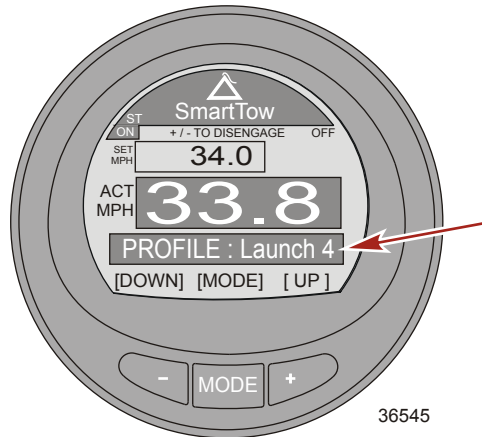

4. To change the launch level, press the "MODE" button and press the "+" or "-" button to change the launch setting.
5. To change the mode of cruise control, press and hold the "MODE" button until the screen changes the mode of cruise control.

## CREATING A CUSTOMIZED LAUNCH SETTING

**NOTE:** Cruise and launch control is only available with Gen I (2007) and newer DTS engines.

**NOTE:** The cruise control minimum and maximum range will vary depending on the type of power package application.

Beyond launch level 5 are eight customized launch settings. Each customized launch setting name can have up to seven characters to identify the custom launch. The custom launch setting can be controlled by RPM or speed. To use the speed setting control, a paddle wheel must be installed, or a SmartCraft GPS puck must be installed.

1. While in the "Main Menu," press the "-" or "+" to highlight the "Propulsion" menu. Press the "MODE" button to enter the "Propulsion" menu.
2. Press the "-" or "+" to highlight the "Smart Tow" screen.

# PROPULSION MENU

3. Press the "MODE" button and an icon of a person skiing will appear on the profile screen for approximately three seconds.
4. While the screen with the icon of a person skiing is visible, press the "+" and go beyond "Launch 5."

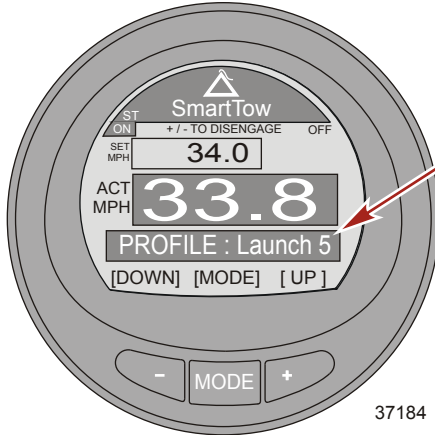

5. The "Profile" window will change to "New User."

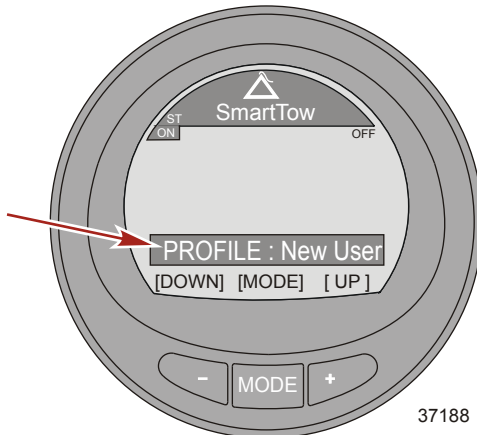

6. After approximately three seconds the edit mode of the "New User" will appear and the new user "Name" will be highlighted.
7. Press the "-" or "+" button to edit and change the alpha character. Press the "MODE" button to move to the next character. Press the "-" or "+" button to edit and change the next alpha character. Continue this process until the custom launch name is complete.

# PROPULSION MENU

**NOTE:** All of the alpha characters must be edited before the "RPM Set Point" can be edited.

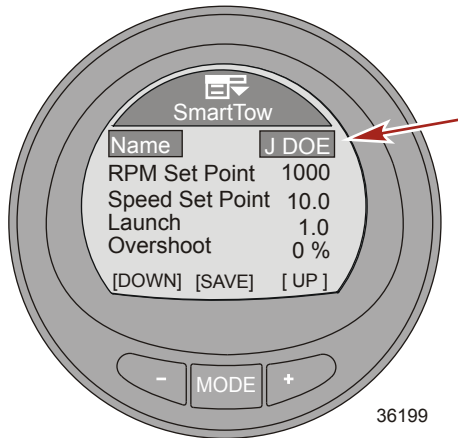

8. Press the "MODE" button to exit the "Name" edit mode.
9. Press the "-" button to highlight the "RPM Set Point."
10. Press the "MODE" button to edit the "RPM Set Point."
11. Press the "-" or "+" button to change the "RPM Set Point."

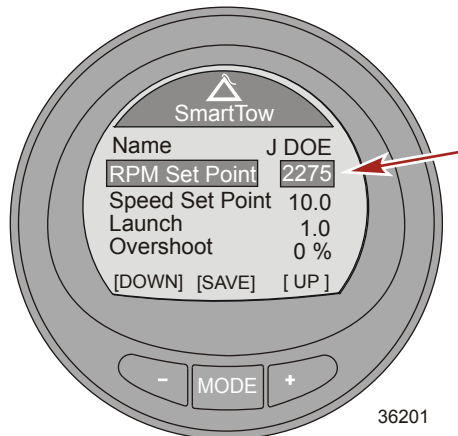

12. Press the "MODE" button to exit the "RPM Set Point" mode.
13. Press the "-" button to highlight the "Speed Set Point."
14. Press the "MODE" button to edit the "Speed Set Point."

# PROPULSION MENU

15. Press the "-" or "+" button to change the "Speed Set Point."

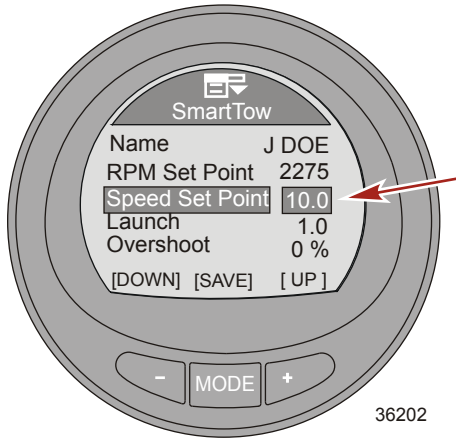

16. Press the "MODE" button to exit the "Speed Set Point" mode.

17. Press the "-" button to highlight "Launch."

18. Press the "MODE" button to edit "Launch."

19. Press the "-" or "+" button to change the "Launch" setting.

**NOTE:** There are five launch levels. Level 1 is the most gradual and level 5 is the most aggressive.

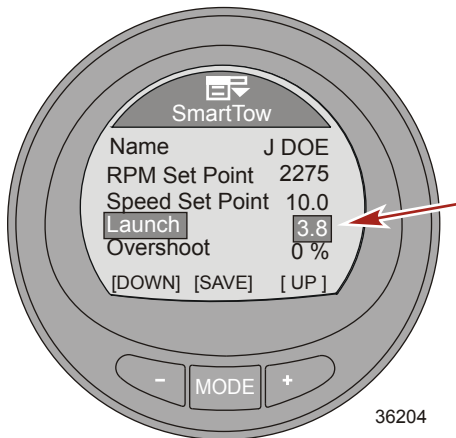

20. Press the "MODE" button to exit the "Launch" mode.

21. Press the "-" button to highlight "Overshoot."

22. Press the "MODE" button to edit "Overshoot."

## PROPULSION MENU

**NOTE:** "Overshoot" is the amount of RPM the engine will achieve above the "RPM Set Point."

23. Press the "-" or "+" button to change the overshoot percentage setting.

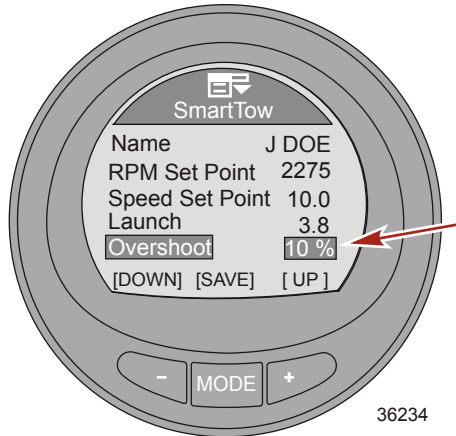

24. Press the "MODE" button to exit the "Overshoot" mode.

25. Press the "-" button to highlight "Duration."

26. Press the "MODE" button to edit "Duration."

**NOTE:** "Duration" is the amount of time the engine RPM "Overshoot" will be allowed.

**IMPORTANT:** The RPM and speed setpoints will change to the last setpoint used for that particular new user when using Smart Tow.

# PROPULSION MENU

27. Press the "-" or "+" button to change the duration seconds.

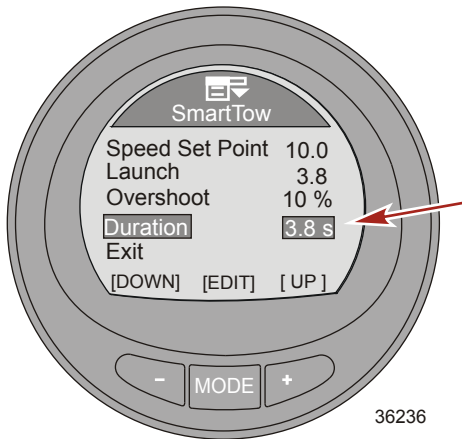

28. Press the "MODE" button to exit the "Duration" mode.

29. Press the "-" button to highlight the "Exit" option.

30. Press the "MODE" button to exit the custom launch mode.

# VESSEL MENU

## Using the Vessel Screens

The vessel menu screens will display information concerning the vessel and associated systems. Screens that are available in the vessel menu may vary according to the engine type, but may include the following:

- Economy (ECO)
- Trip data
- Heating, ventilation, and air conditioning (HVAC)
- Generator data
- Range
- Trim
- Fuel tank1
- Tank 2
- Tabs
- GPS information
- Waypoint information
- Steering position
- Depth

## Available Vessel Screens

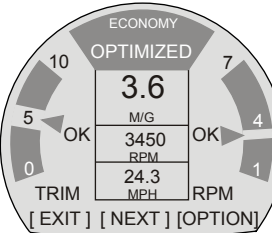

<p>Economy (ECO)</p>	<p>The software for the economy screen monitors the engine sensors and looks for the best fuel economy number while running the boat. When the software recognizes an improvement in the fuel economy, the gauge records what the trim and engine RPM values are at that time. This calculation happens whether the ECO screen is visible or not. When the software has recorded the RPM and trim values, it will guide the operator with arrows, to where that optimum running speed and trim setting was. The ECO screen does not need any calibration, although there are settings to customize the gauge for your boating style. The economy screen optimized values can be reset.</p>	
----------------------	--	--

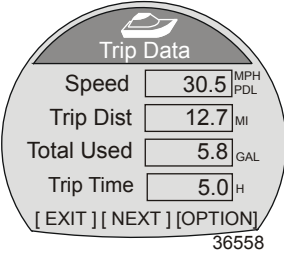
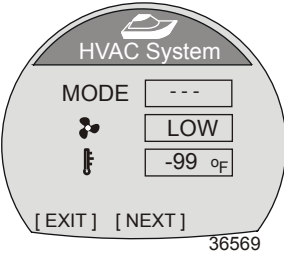
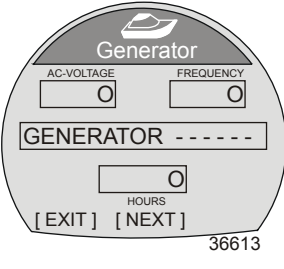
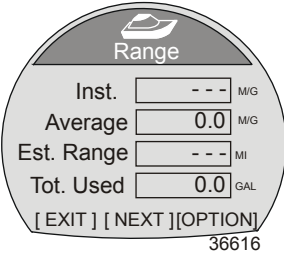
# VESSEL MENU

<p>Trip Data</p>	<p>Displays the vessel speed through the available sensor, the current trip distance, the total amount of fuel used, and the current amount of time during the trip. The distance, fuel used, and time can be reset.</p>	
<p>HVAC System</p>	<p>Displays whether the unit is in a heating or cooling mode, the speed of the fan, and the current temperature. The HVAC unit must be interfaced with the CAN communication for this option to display information.</p> <p><b>NOTE:</b> HVAC currently has no validated manufacturers.</p>	
<p>Generator</p>	<p>Displays the AC voltage, the hertz frequency, the generator location or name, and the generator running hours. The generator unit must be interfaced with the CAN communication for this option to display information.</p>	
<p>Range</p>	<p>Displays the current amount of fuel economy, the average amount of fuel used, the estimated distance the vessel can travel based on the current usage, and the total amount of fuel used. The average fuel used and the total amount used can be reset.</p>	

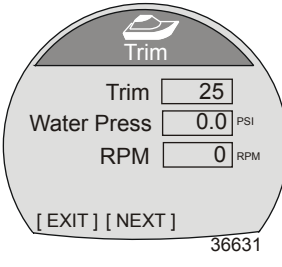
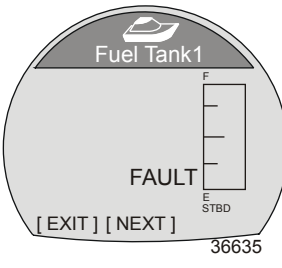

# VESSEL MENU

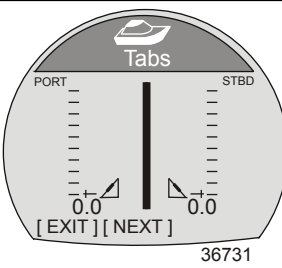
<p>Trim</p>	<p>Displays a number relating to the position of the trim system, the engine water pressure, and the engine RPM.</p>	 <p>Trim <input type="text" value="25"/>          Water Press <input type="text" value="0.0"/> PSI          RPM <input type="text" value="0"/> RPM          [EXIT] [NEXT]          36631</p>
<p>Fuel Tank1</p>	<p>Displays the level of the fuel tank, the location of the fuel tank, and will display "FAULT" when there is a problem with the fuel tank.</p>	 <p>Fuel Tank1          F          [FAULT]          E          STBD          [EXIT] [NEXT]          36635</p>
<p>Tank 2</p>	<p>Tank 2 can be selected as not installed, fuel, water, or waste when connected to a four-stroke engine. When selected as fuel, the level can be calibrated with a default setting, or by adding fuel. When selected as water or waste, the level is calibrated to the default setting.</p>	 <p>Water Tank          F          0 %          E          STBD          [EXIT] [NEXT]          36637</p>
<p>Tabs</p>	<p>Displays the position of the tabs with numbers and a bar graph for each tab.</p>	 <p>Tabs          PORT STBD          [0.0] [0.0]          [EXIT] [NEXT]          36731</p>

# VESSEL MENU

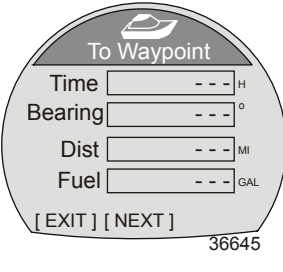
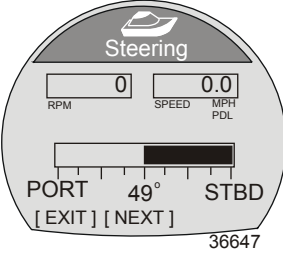
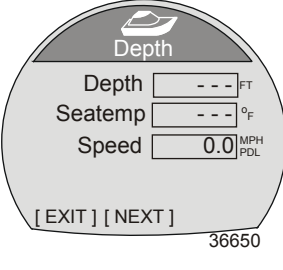
<p>GPS</p>	<p>Displays the course over ground ("COG"), speed over ground ("SOG"), latitude position ("LAT"), and longitude position ("LON"). A GPS must be installed for this option to display information.</p>	 <p>The GPS menu screen features a boat icon at the top. Below it, the title "GPS" is centered. There are four data fields: "COG" with a value of "---" and a degree symbol, "SOG" with a value of "---" and "MPH", "LAT" with a value of "---", and "LON" with a value of "---". At the bottom, there are two buttons: "[ EXIT ]" and "[ NEXT ]". The screen number "36642" is in the bottom right corner.</p>
<p>To Waypoint</p>	<p>Displays the amount of time to the waypoint, the compass bearing towards the waypoint, the distance to the waypoint, and the amount of fuel required to the waypoint. A GPS must be installed with a SmartCraft puck for this option to display information.</p>	 <p>The "To Waypoint" menu screen features a boat icon at the top. Below it, the title "To Waypoint" is centered. There are four data fields: "Time" with a value of "---" and "H", "Bearing" with a value of "---" and a degree symbol, "Dist" with a value of "---" and "MI", and "Fuel" with a value of "---" and "GAL". At the bottom, there are two buttons: "[ EXIT ]" and "[ NEXT ]". The screen number "36645" is in the bottom right corner.</p>
<p>Steering</p>	<p>Displays the engine RPM, the vessel speed through the active sensor, and the direction of the steering; port or starboard. A steering position sensor must be installed for this screen to display the steering direction and relative position.</p>	 <p>The "Steering" menu screen features a boat icon at the top. Below it, the title "Steering" is centered. There are two data fields: "RPM" with a value of "0" and "SPEED" with a value of "0.0". Below these is a steering direction gauge with "PORT" on the left, "49°" in the center, and "STBD" on the right. At the bottom, there are two buttons: "[ EXIT ]" and "[ NEXT ]". The screen number "36647" is in the bottom right corner.</p>
<p>Depth</p>	<p>Displays the depth of the water, the temperature of the water, and the speed of the vessel through the active sensor.</p>	 <p>The "Depth" menu screen features a boat icon at the top. Below it, the title "Depth" is centered. There are three data fields: "Depth" with a value of "---" and "FT", "Seatemp" with a value of "---" and a degree symbol and "F", and "Speed" with a value of "0.0" and "MPH PDL". At the bottom, there are two buttons: "[ EXIT ]" and "[ NEXT ]". The screen number "36650" is in the bottom right corner.</p>

# VESSEL MENU

## Economy (ECO) Screen

The economy screen monitors the engine sensors and looks for the best fuel economy number while the vessel is under way. When the software recognizes an improvement in the fuel economy, the gauge records what the trim and engine RPM values are at that time. This calculation happens whether the ECO screen is visible or not. When the software has recorded the RPM and trim values, it will guide the operator with arrows to where that optimum running speed and trim setting was. **The ECO screen does not need any calibration**, although there are settings to customize the gauge for your boating style. The default settings are within acceptable parameters for most vessel applications. When the economy screen is "OPTIMIZED," the backlighting of the screen will turn to green. While "OPTIMIZED," the trim and RPM arrows will be aligned with the economy target windows. When either the trim or RPM arrows are outside the target window, the arrows will become hollow and the backlighting will turn to yellow. These color changes are difficult to identify in the sunlight. The target windows can be made smaller or larger. The menu path to change the target window size is: "Settings," > "ECO," > "Trim Accuracy [%]" for trim, or "RPM Accuracy [%]" for RPM. The default number of 4 is generally a good setting for most vessel configurations. The higher the number, the larger the target window.

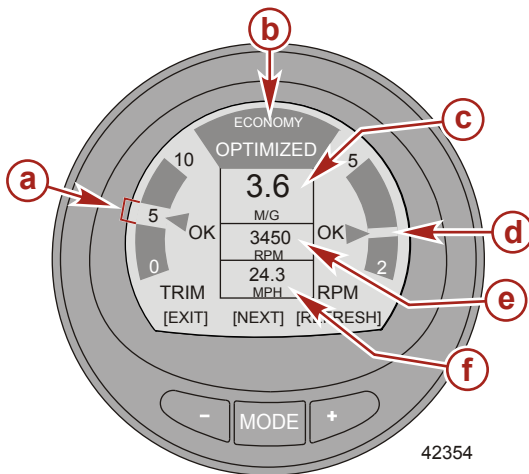

- a - Trim target window
- b - Economy optimized
- c - Fuel economy
- d - RPM target window
- e - RPM
- f - Vessel speed

# VESSEL MENU

- If the software has recorded an economy value that is better than where you are currently, the screen will show "NOT OPTIMIZED" at the top of the screen and the backlighting will turn to the color yellow. This color change is difficult to identify in the sunlight. The trim position arrow will become hollow, a guide arrow will appear indicating the trim position must be changed either up or down, and the recorded target window will appear in a new location. Pressing the refresh button "+" ("REFRESH") at any time while the economy screen is visible will restart the economy calculations.

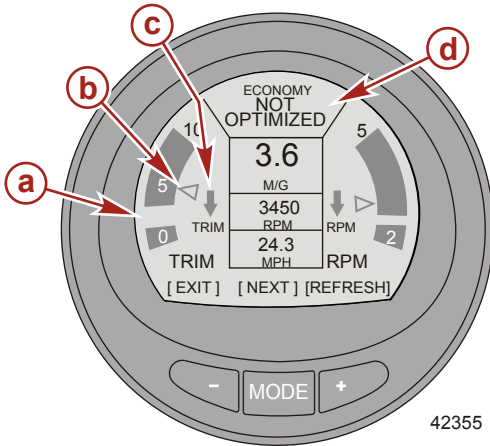

- a** - New recorded target window
- b** - Hollow arrow
- c** - Guide arrow indicating direction change
- d** - Screen showing "NOT OPTIMIZED"

42355

- When the trim target is achieved, the trim position arrow will no longer be hollow, and "OK" will replace the guide arrow.

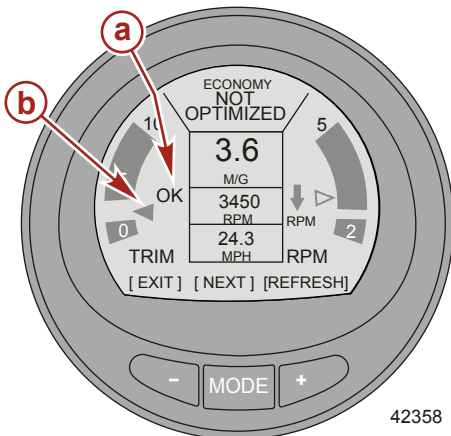

- a** - Trim position arrow not hollow
- b** - "OK" replaces guide arrow

42358

## VESSEL MENU

- The RPM position arrow will become hollow, a guide arrow will appear indicating the RPM must be raised or lowered, and the recorded target window will appear in a new location.

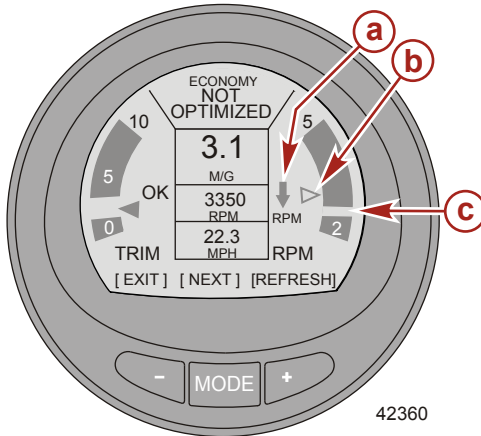

- a** - Guide arrow indicating direction change
- b** - Hollow arrow
- c** - New recorded target window

- When the RPM target is achieved, the RPM arrow will no longer be hollow, and "OK" will replace the guide arrow. The screen will change color from yellow to green indicating the engine is at the optimized running RPM and trim position. The color change is difficult to identify in the sunlight.

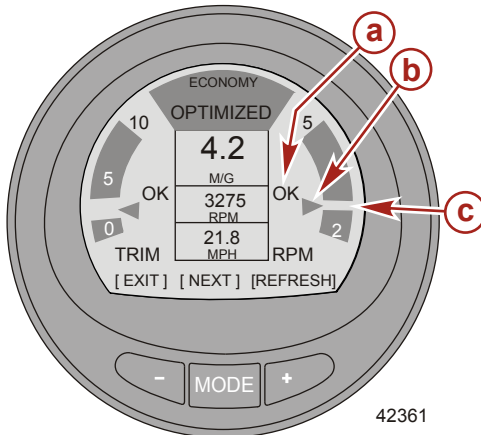

- a** - "OK" replaces guide arrow
- b** - Trim position arrow not hollow
- c** - New recorded target window

# VESSEL MENU

- If the RPM exceeds the maximum selected RPM in the "Settings" menu, the screen will change color and advised to decrease the RPM below the selected RPM.

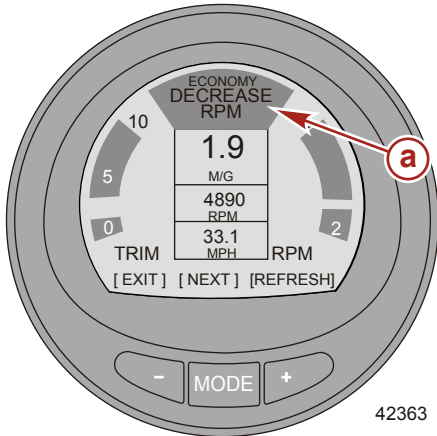

**a** - Decrease RPM screen

- To change the maximum selected RPM, go to the economy screen in the "Settings" menu. The menu path is: "Settings," > "ECO," > "Max RPM." The default setting is 4300.

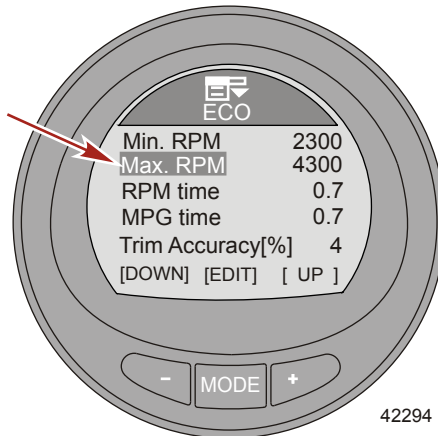

# VESSEL MENU

- If the RPM drops below the minimum selected RPM in the "Settings" menu, the screen will change color and advised to increase the RPM above the selected RPM.

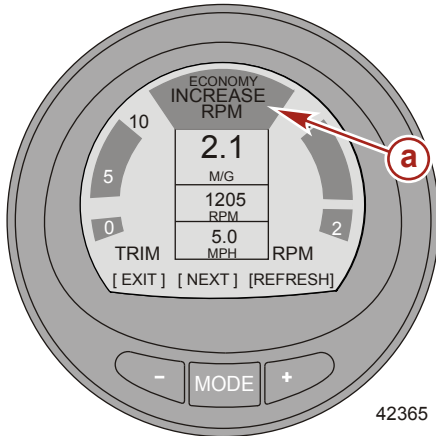

**a** - Increase RPM screen

- To change the minimum selected RPM, go to the economy screen in the "Settings" menu. The menu path is: "Settings," > "ECO," > "Min RPM." The default setting is 2300 RPM.

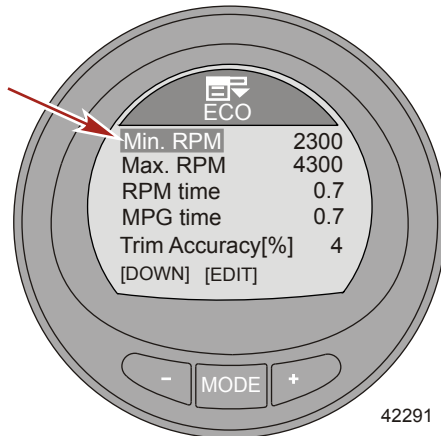

# VESSEL MENU

## ECONOMY RESET

- To recalculate the RPM and trim targets, press the "REFRESH (+)" button. The gauge software will calculate the targets for the maximum economy.

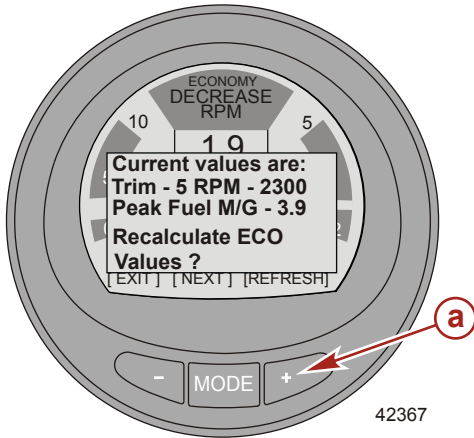

**a** - "REFRESH (+)" button

## Trip Data Screen

The "Trip Data" screen displays the current vessel speed. This data is based on which sensor is active; pitot sensor, paddle wheel, or GPS. The type of speed sensor is displayed on the right side of the "Speed" information window. When the transition speed is reached, the new active speed sensor will then be displayed.

The trip distance ("Trip Dist") will display how far the vessel has traveled. The trip distance can be reset.

The total fuel used ("Total Used") is the total of all the engines running on the vessel, displaying how much fuel has been used down to a tenth of the unit. The total fuel used can be reset.



# VESSEL MENU

The current amount of time the trip has taken ("Trip Time") will be displayed in tenths of an hour. The trip time can be reset.

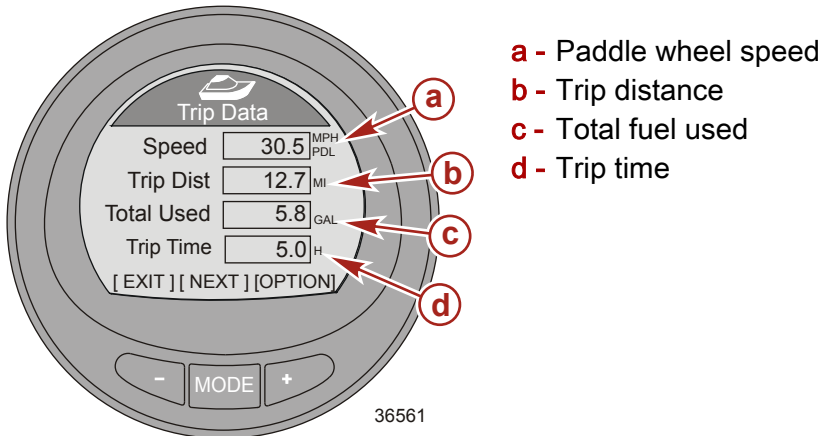

## RESETTING THE TRIP DATA INFORMATION

1. While the "Trip Data" option screen is visible, press the "+" button to open the reset option.
2. A pop-up window will appear asking to reset the trip distance ("Trip Distance Reset?").
3. Press the "-" button for "Yes," or press the "+" button for "No."

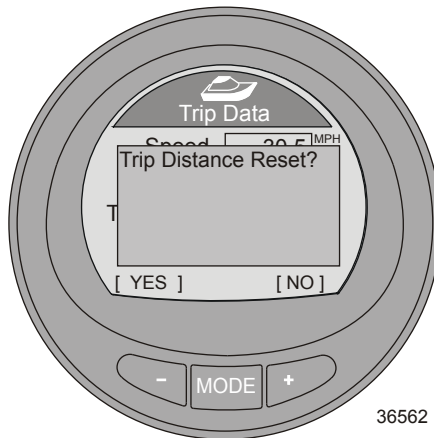

4. The next pop-up window will appear asking to reset the trip time ("Trip Time Reset?").

# VESSEL MENU

5. Press the "-" button for "Yes," or press the "+" button for "No."

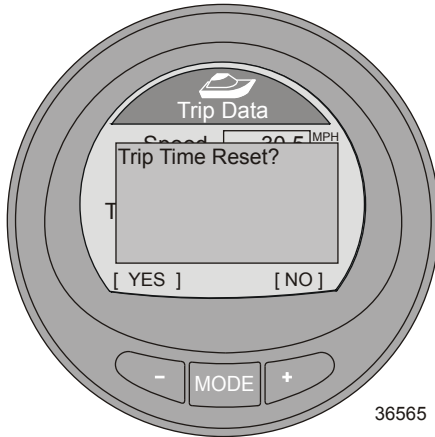

6. The next pop-up window will appear asking to reset the amount of fuel used ("Fuel Used Reset?").
7. Press the "-" button for "Yes," or press the "+" button for "No".

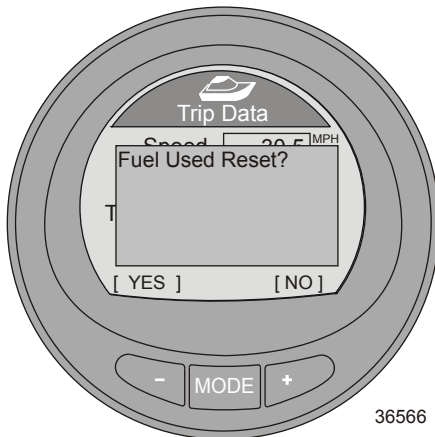

8. Press the "-" button to return to the "Main Menu," or press the "MODE" button to go to the next screen.

# VESSEL MENU

## Heating, Ventilation, and Air Conditioning Screen

The heating, ventilation, and air conditioning system ("HVAC System") screen displays the present state of the unit, whether it is in a cooling mode or heating mode. The HVAC fan speed and the current temperature is displayed. The HVAC unit must be interfaced with the CAN communication for this option to display information. By default, when the HVAC unit is not interfaced with the CAN communication, the temperature will be displayed as a negative number.

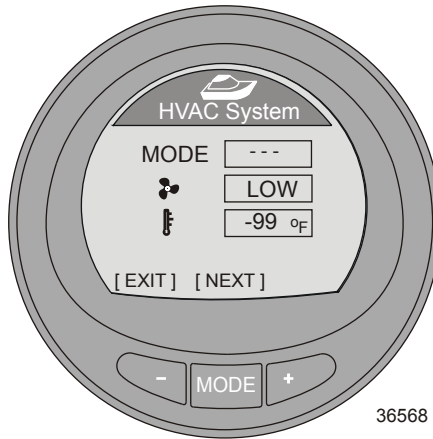

Press the "-" button to return to the "Main Menu," or press the "MODE" button to go to the next screen.

# VESSEL MENU

## Generator Screen

The "Generator" screen displays the AC voltage, the hertz frequency the generator is producing, the generator location or name, and the generator running hours. The generator unit must be interfaced with the CAN communication for this option to display information.

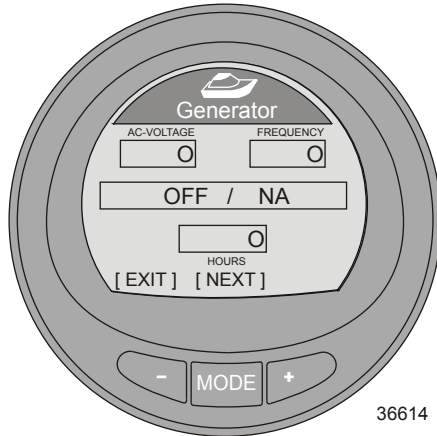

Press the "-" button to return to the "Main Menu," or press the "MODE" button to go to the next screen.

# VESSEL MENU

## Range Screen

The "Range" screen displays the current amount of fuel economy, the average amount of fuel used, the estimated distance the vessel can travel based on the current usage, and the total amount of fuel used. The average fuel used and the total amount used can be reset.

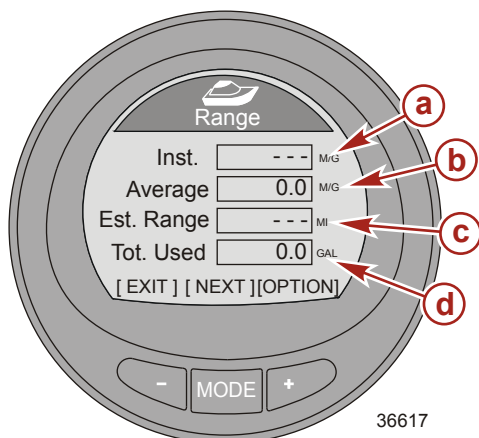

- a** - Current fuel economy
- b** - Average fuel used
- c** - Estimated distance
- d** - Total fuel used

## RESET RANGE SCREEN OPTIONS

1. To reset the average fuel used, press the "+" button to access the reset option.
2. A pop-up screen will appear asking if the average fuel economy should be reset ("Average Fuel Eco Reset?").
3. Press the "-" button for "Yes," or press the "+" button for "No".

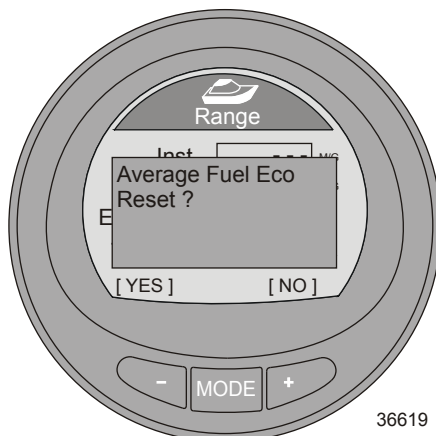

# VESSEL MENU

4. After pressing either button, a pop-up window appears asking if the total fuel used should be reset ("Fuel Used Reset?").
5. Press the "-" button for "Yes," or press the "+" button for "No."

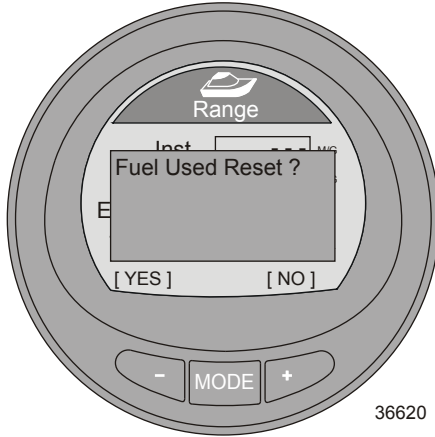

6. Press the "-" button to return to the "Main Menu," or press the "MODE" button to go to the next screen.

## Trim Screen

The "Trim" screen displays a number relating to the position of the trim system, the engine water pressure, and the engine RPM.

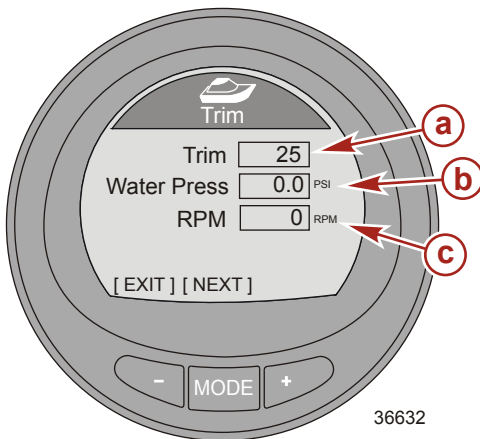

- a** - Trim position number
- b** - Water pressure
- c** - Engine RPM

# VESSEL MENU

Press the "-" button to return to the "Main Menu," or press the "MODE" button to go to the next screen.

## Tanks

### FUEL TANK 1

The "Fuel Tank 1" screen displays the level of the fuel tank, the location of the fuel tank, and will display "FAULT" when there is a problem with the fuel tank. It can also be selected as not installed ("Not inst"). When selected as not installed, the "Fuel Tank 1" screen will not be accessible.

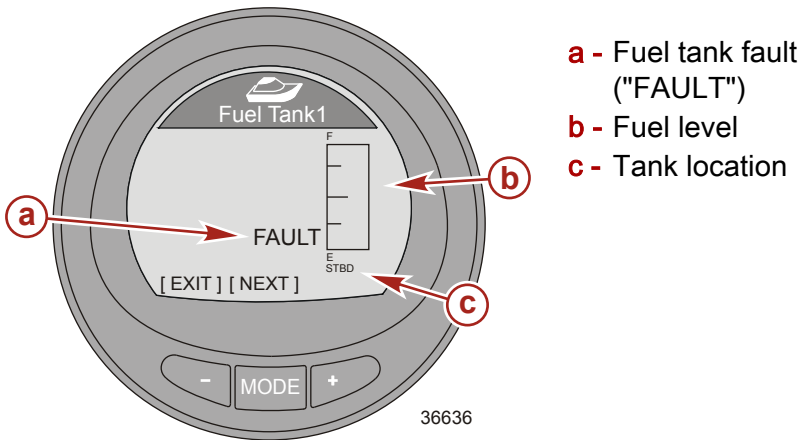

### TANK 2

"Tank 2" can be selected as not installed ("Not inst"), fuel, water, or waste when connected to a four-stroke engine. When selected as fuel, the level can be calibrated with a default setting, or by adding fuel. When selected as water or waste, the level is automatically calibrated to the default setting.

# VESSEL MENU

When the gauge is installed on a vessel with a two-stroke engine, "Tank 2" will automatically default to oil.

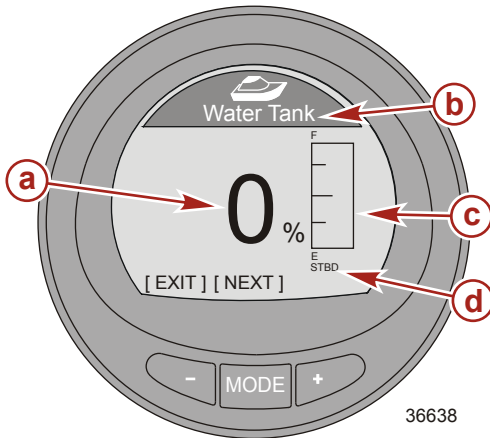

- a** - Tank level percentage
- b** - Tank type
- c** - Tank level
- d** - Tank location

Press the "-" button to return to the "Main Menu," or press the "MODE" button to go to the next screen.

## Tabs Screen

The "Tabs" screen displays the port tab and starboard tab position with a bar graph and numbers.

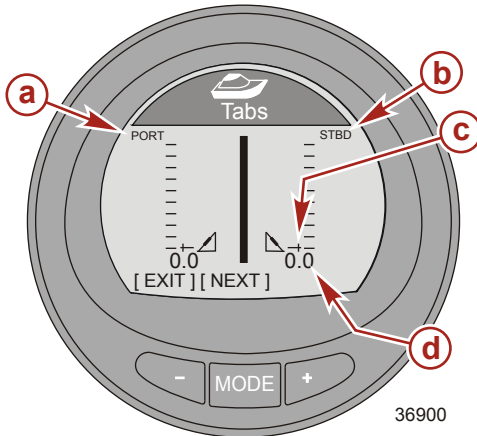

- a** - Port tab bar graph
- b** - Starboard tab bar graph
- c** - Bar graph pointer
- d** - Tab position number

Press the "-" button to return to the "Main Menu," or press the "MODE" button to go to the next screen.



# VESSEL MENU

## GPS Screen

The "GPS" screen displays the course over ground ("COG"), speed over ground ("SOG"), latitude position ("LAT"), and longitude position ("LON"). A GPS must be installed for this option to display information.

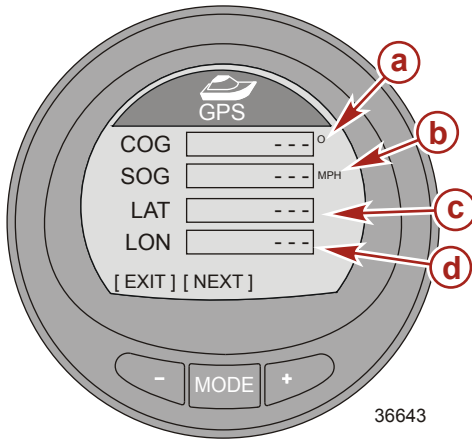

- a** - Course over ground ("COG")
- b** - Speed over ground ("SOG")
- c** - Latitude position ("LAT")
- d** - Longitude position ("LON")

Press the "-" button to return to the "Main Menu," or press the "MODE" button to go to the next screen.

# VESSEL MENU

## To Waypoint Screen

The "To Waypoint" screen displays the amount of time required to reach the waypoint, the compass bearing towards the waypoint, the distance to the waypoint, and the amount of fuel required to the waypoint. A GPS must be installed with a SmartCraft puck for this option to display information.

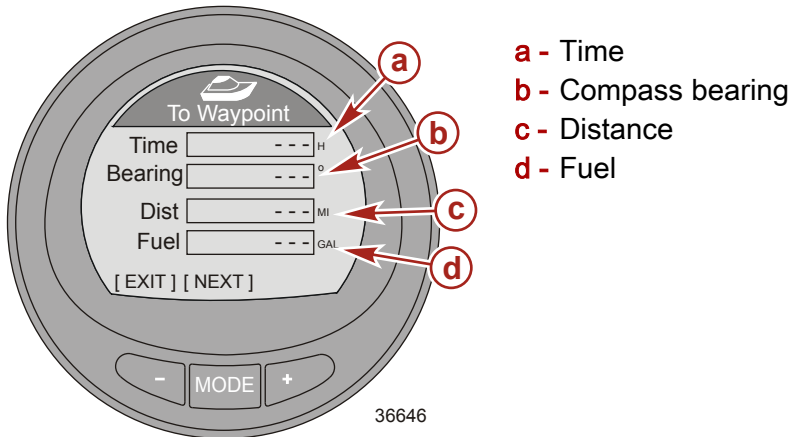

Press the "-" button to return to the "Main Menu," or press the "MODE" button to go to the next screen.

# VESSEL MENU

## Steering Screen

The "Steering" screen displays the engine RPM, the vessel speed, a bar graph indicating the direction of the steering ("PORT" or "STBD"), and a number displayed to indicate the relative position of the steering. A steering position sensor must be installed for this screen to display the steering direction and relative position.

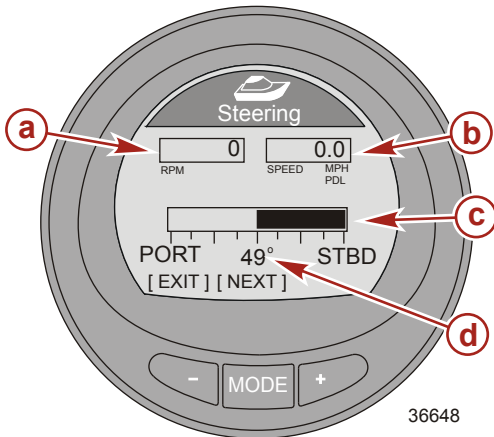

- a** - Engine RPM
- b** - Vessel speed
- c** - Steering bar graph
- d** - Relative position of the steering

36648

Press the "-" button to return to the "Main Menu," or press the "MODE" button to go to the next screen.

# VESSEL MENU

## Depth Screen

The "Depth" screen displays the depth of the water, the temperature of the water, and the speed of the vessel through the available sensor. The actual depth may be different from what is displayed and is dependant on the amount of offset that is programmed in the "Settings" menu.

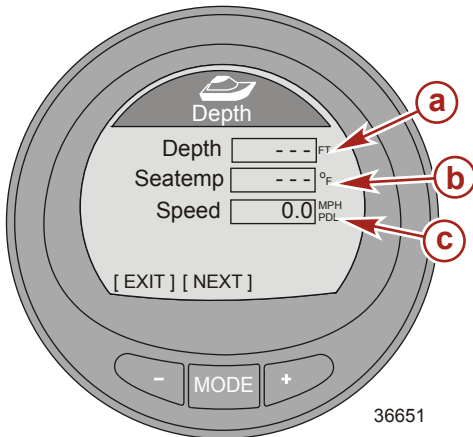

- a** - Depth
- b** - Water temperature
- c** - Vessel speed

Press the "-" button to return to the "Main Menu," or press the "MODE" button to go to the next screen.

# FULL SCREENS



## Full Screens Features and Options

The "Full Screens" menu displays large icon vessel and propulsion data in addition to "Tri Data" screens. Several screens show a minimum, maximum reference with an arrow directing your attention to the current value displayed within the screen. The minimum, maximum reference limits are the same minimum and maximum limits that are shown on a System Link gauge. Additionally, a number of screens allow the resetting of peak RPM or speed data. The "Full Screens" and "Tri Data" screen must be turned on ("Yes") for these screens to be active in the "Full Screens" menu. The menu path to turn the full screens data on is: "Main Menu," > "Settings," > "Screens," > "Full Screens." The menu path to select the "Tri Data" information is: "Main Menu," > "Settings," > "Screens," > "Tri Data."



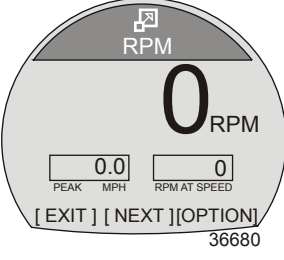

- The following list shows the available information for selecting full screens data.
  - Speed
  - Depth
  - Coolant temperature
  - Clock
  - Oil temperature
  - Fuel pressure
  - Oil pressure
  - Water pressure
  - Tri data
- The following list shows the available information for setting up to five tri data screens.
  - Hours
  - Clock
  - Depth
  - RPM
  - Speed
  - Coolant temperature

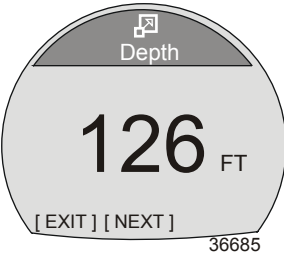
# FULL SCREENS

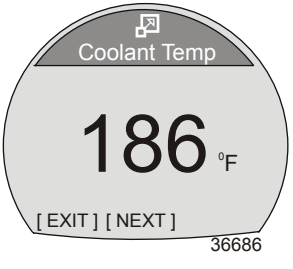

- Oil temperature
- Seawater temperature
- Water pressure
- Oil pressure
- Trim
- Fuel flow
- Battery

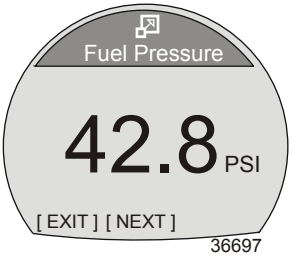
<p>RPM</p>	<p>Displays large numbers for the engine RPM, shows the peak speed, and the peak RPM at speed. The peak values can be reset.</p>	 <p>The RPM full screen display features a large central '0' with 'RPM' to its right. Above the display is a 'RPM' label with a small icon. Below the main display are two smaller boxes: '0.0' labeled 'PEAK MPH' and '0' labeled 'RPM AT SPEED'. At the bottom, there are navigation buttons: '[EXIT] [NEXT] [OPTION]' and a version number '36680'.</p>
<p>Speed</p>	<p>Displays large numbers for the vessel speed through the available sensor, the peak speed, and the peak RPM at speed. The peak values can be reset.</p>	 <p>The Speed full screen display features a large central '0.0' with 'MPH' to its right and 'PDL' above it. Above the display is a 'Speed' label with a small icon. Below the main display are two smaller boxes: '0.0' labeled 'PEAK MPH' and '0' labeled 'RPM AT SPEED'. At the bottom, there are navigation buttons: '[EXIT] [NEXT] [OPTION]' and a version number '36681'.</p>
<p>Depth</p>	<p>Displays the water depth in large numbers.</p>	 <p>The Depth full screen display features a large central '126' with 'FT' to its right. Above the display is a 'Depth' label with a small icon. Below the main display are navigation buttons: '[EXIT] [NEXT]' and a version number '36685'.</p>

# FULL SCREENS

<p>Coolant Temperature</p>	<p>Displays the engine coolant temperature in large numbers.</p>	 <p>The display shows 'Coolant Temp' at the top, a large '186 °F' in the center, '[EXIT] [NEXT]' below it, and the number '36686' at the bottom right.</p>
<p>Oil Temperature</p>	<p>Displays the engine oil temperature in large numbers.</p>	 <p>The display shows 'Oil Temp' at the top, a large '205 °F' in the center, '[EXIT] [NEXT]' below it, and the number '36693' at the bottom right.</p>
<p>Fuel Pressure</p>	<p>Displays the engine fuel pressure in large numbers.</p>	 <p>The display shows 'Fuel Pressure' at the top, a large '42.8 PSI' in the center, '[EXIT] [NEXT]' below it, and the number '36697' at the bottom right.</p>
<p>Oil Pressure</p>	<p>Displays the engine oil pressure in large numbers.</p>	 <p>The display shows 'Oil Pressure' at the top, a large '40.2 PSI' in the center, '[EXIT] [NEXT]' below it, and the number '36698' at the bottom right.</p>

## FULL SCREENS

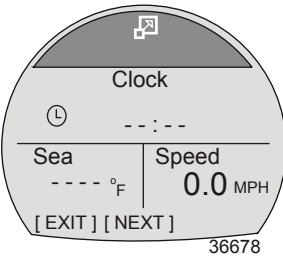
<p>Water Pressure</p>	<p>Displays the engine water pressure in large numbers.</p>	 <p>The display shows 'Water Press' at the top, a large '30.2 PSI' in the center, and '[EXIT] [NEXT]' at the bottom. The number '36701' is in the bottom right corner.</p>
<p>Clock</p>	<p>Displays the time in large numbers. Can be displayed as 24 hour or 12 hour.</p>	 <p>The display shows 'Clock' at the top, a large '23:15' in the center, and '[EXIT] [NEXT]' at the bottom. The number '36702' is in the bottom right corner.</p>
<p>Tri Data</p>	<p>Displays vessel and propulsion data selected and arranged by the user. Up to five tri data screens can be customized by the user.</p>	 <p>The display shows 'Clock' at the top. Below it is a clock icon and '---:--'. A horizontal line separates the top from the bottom. Below the line, 'Sea' is on the left with '---- °F' below it, and 'Speed' is on the right with '0.0 MPH' below it. '[EXIT] [NEXT]' is at the bottom. The number '36678' is in the bottom right corner.</p>

### RESETTING PEAK VALUES

The "RPM" and "Speed" full screens will record and store the vessel peak speed and the RPM at that peak speed. These peak values can be reset to capture new RPM and speed data.



# FULL SCREENS

1. While the "RPM" or "Speed" full screen is visible, press the "+" button to open the reset option.

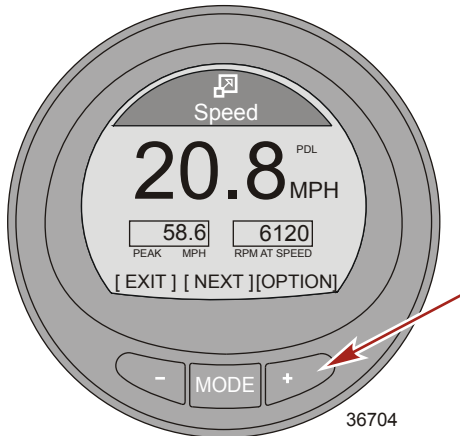

2. A pop-up window will appear asking if the peak values should be reset ("Reset Peak Values").
3. Press the "+" button if you do not want to reset the values "[NO]."
4. Press the "-" button if you want to reset the values "[YES]."

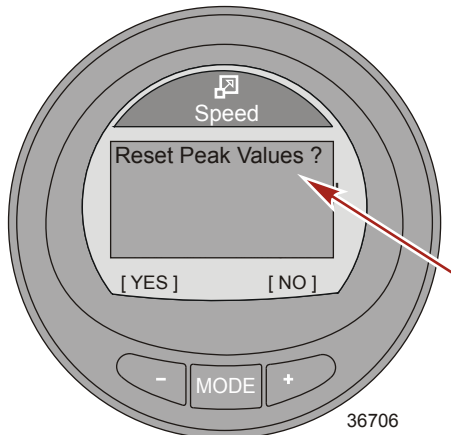

5. When the selection is "[YES]," the pop-up window will close and the new data will populate the peak values immediately.

# FAVORITE SCREENS

## Favorites Screen Features and Options

The "Favorites" is an optional feature that will show specific screens selected by the operator to be reviewed quickly. The favorites will remain on the screen for a specific amount of time. This time can be one second up to 30 seconds. Up to nine favorite screens can be selected from the "Propulsion" menu, "Vessel" menu, or "Full Screens" menu. After selecting the screen desired to be displayed on the favorites, use the "-" or "+" button to highlight the "Favorites" menu option. Press the "MODE" button to view the favorites.

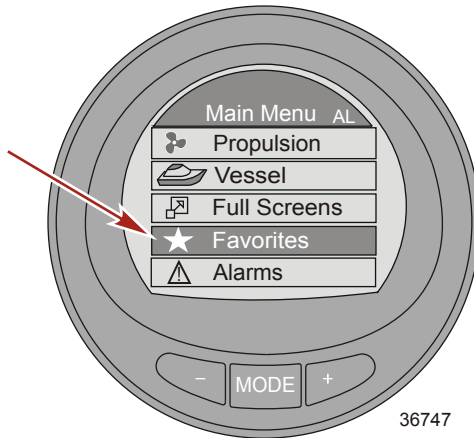

# FAVORITE SCREENS

## SELECTING A FAVORITE SCREEN

1. From the "Main Menu," press the "-" or "+" button to select either the "Propulsion," "Vessel," or "Full Screens" menu.

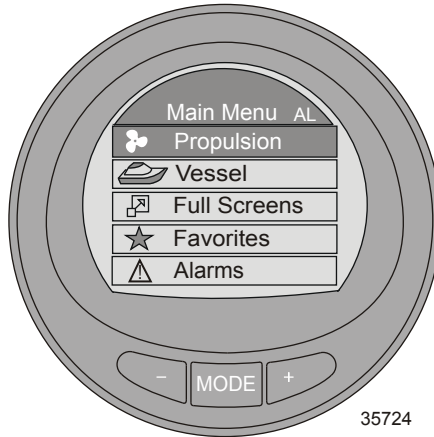

2. Press the "MODE" button to enter the selected menu.
3. Press the "-" or "+" button and select a screen to be a favorite.

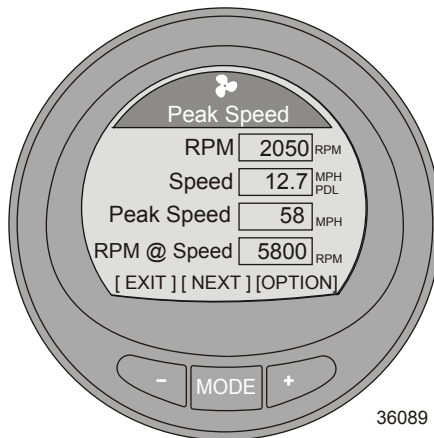

## FAVORITE SCREENS

4. Press the "-" button and the "+" button at the same time and hold the buttons in until the pop-up window appears asking to add the screen to the favorites ("Add to Favorites?").

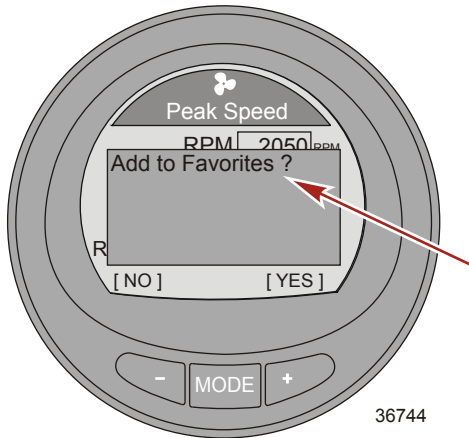

5. Press the "+" button to save the screen to the "Favorites" menu. If the screen is not wanted, press the "-" button to discard the screen option.
6. Press the "MODE" button to page through the menu to select a different screen, or press the "-" button to exit the menu and return to the "Main Menu."
7. Continue the selection process for up to nine selected favorites.

### CHANGING THE FAVORITES SCREEN DURATION

The favorites individual screen will remain visible for a specific amount of time. This time can be set from one second up to 30 seconds.

# FAVORITE SCREENS

1. To change the favorites screen duration, go to the "Main Menu" and press the "-" or "+" button to highlight the "Settings" menu.

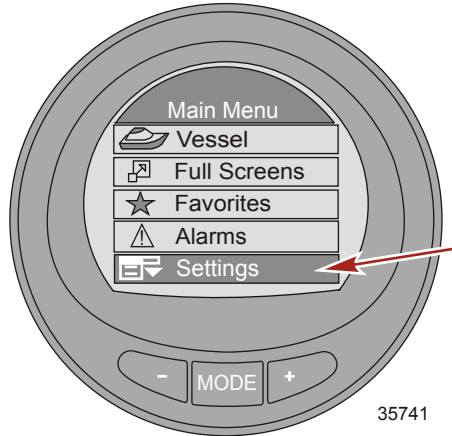

2. Press the "MODE" button to enter the "Settings" menu.
3. Press the "-" button to highlight the "Screen" menu.

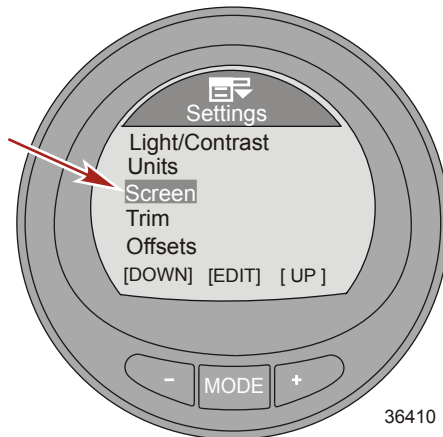

4. Press the "MODE" button to enter the "Screen" menu.
5. Press the "-" or "+" button to highlight the "Favorites Slide" option.
6. Press the "MODE" button to edit the number of seconds the favorites will display.

# FAVORITE SCREENS

7. Press the "-" or "+" button to change the number of seconds.

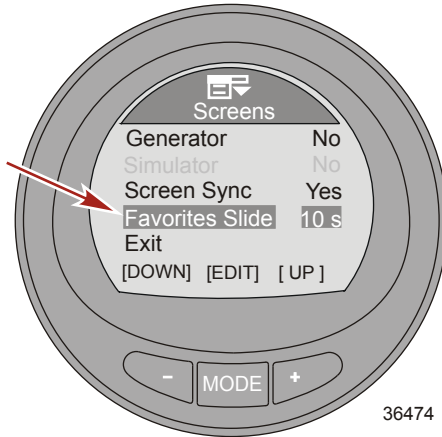

## DELETING A FAVORITE

1. Select the screen that is to be deleted.
2. Press the "-" button and the "+" button at the same time and hold the buttons in until the pop-up window appears asking to remove the screen from the favorites ("Remove from Favorites?").

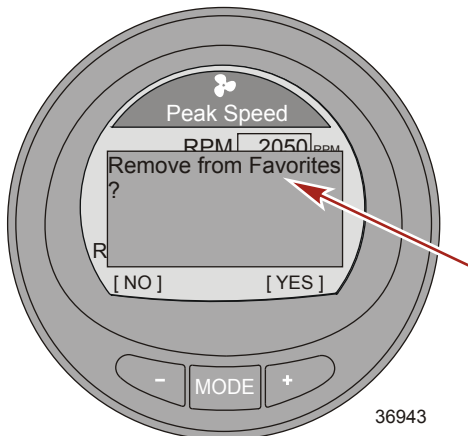

3. Press the "+" button to remove the screen from the "Favorites" menu. Press the "-" button to keep the screen as a favorite.

## FAVORITE SCREENS

4. Press the "MODE" button to page through the menu to select a different screen, or press the "-" button to exit the menu and return to the "Main Menu."

# ALARMS

## Alarms Screen

The "Alarms" screen will display two different fault screens. The screen displays the flashing triangle for system related faults followed by the fault descriptive short text with the fault number. Press the "+" to view the fault descriptive long text, and the recommended action to take. A flashing "AL" will be in the upper right side of the screen.

1. To view all system alarms while in the "Main Menu," press the "-" or "+" button to highlight the "Alarms" menu option.
2. Press the "MODE" button to enter the "Alarms" menu option.

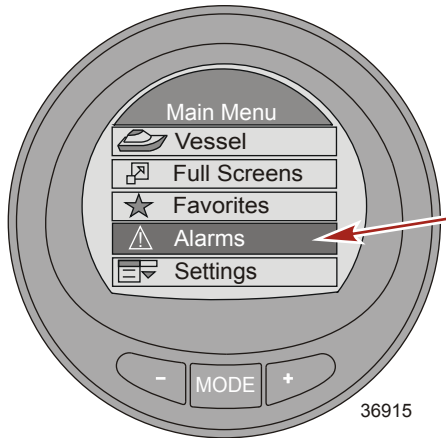



# ALARMS

- The first window will display a flashing triangle icon indicating there is a fault within the system. The window will quickly change to the descriptive text information.

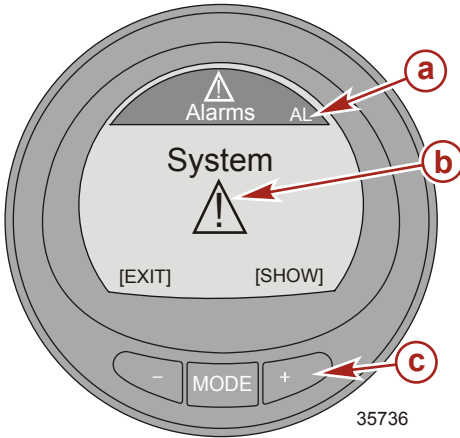

- a** - Flashing "AL" alarm
- b** - Flashing warning icon
- c** - "+" button to show descriptive text

- The screen shows the fault location, fault code number, and the faulty component in short descriptive text.

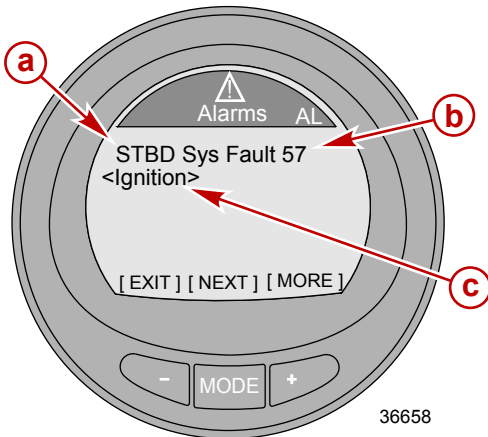

- a** - Location
- b** - Fault code number
- c** - Component

# ALARMS

5. Press the "+" button to view the long descriptive text.

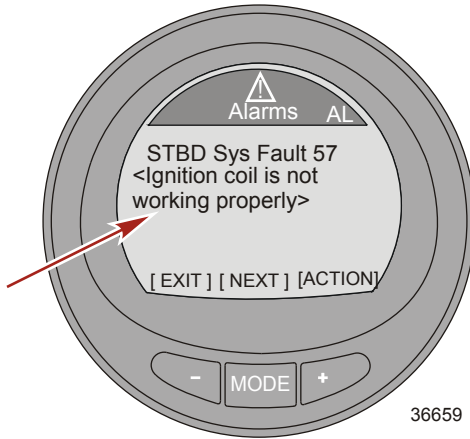

6. Press the "+" button to view the recommended action to take.

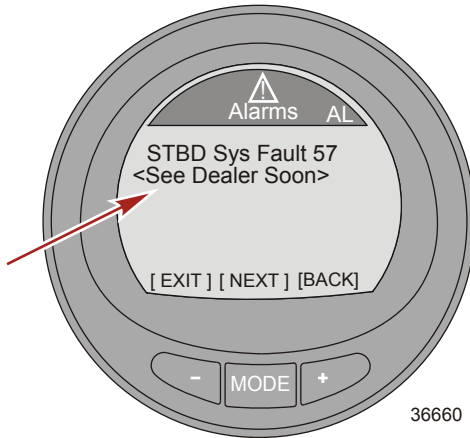

# ALARMS

7. Press the "MODE" button to view the next fault text.

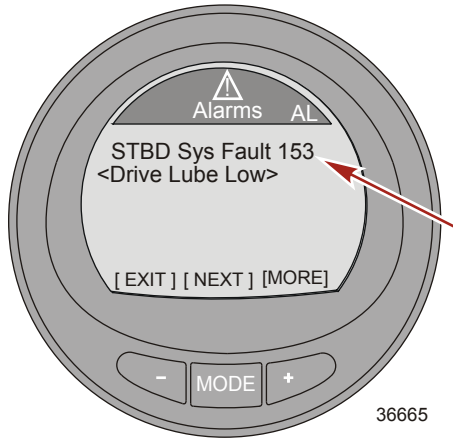

8. Press the "+" button to view the long descriptive text. When the long descriptive text exceeds the screen capacity, several dots at the end of the screen text capacity will be visible.

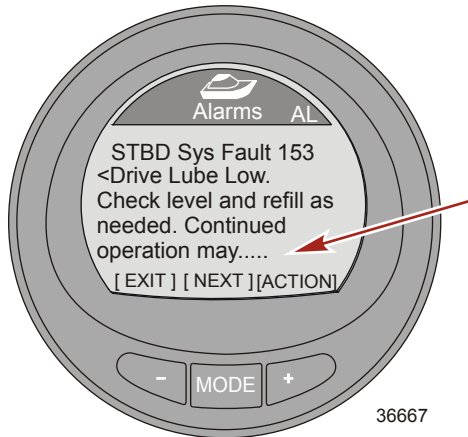

# ALARMS

9. Press the "+" button to view the remaining long descriptive text.

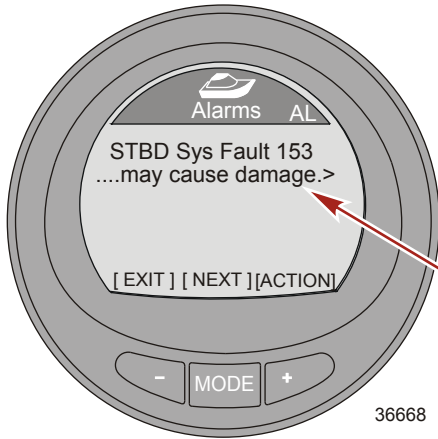

10. Press the "+" button to view the recommended action to take.

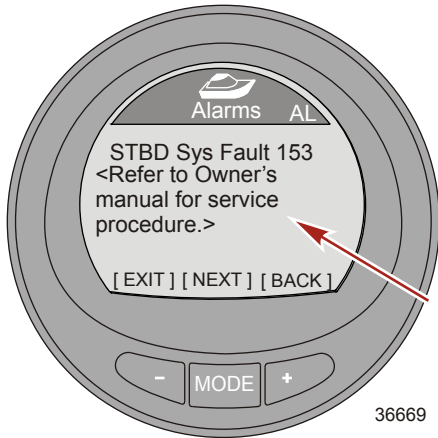

11. Press the "+" button to return to the short descriptive text fault screen, or press the "MODE" button to view the next alarm fault, or press the "-" button to exit the descriptive text screen.

12. Press the "-" button to exit the "Alarms" menu and return to the "Main Menu."

# OWNERS ASSISTANCE

## Local Repair Service

Always return your outboard to your local authorized dealer should the need for service arise. Only he has the factory trained mechanics, knowledge, special tools, equipment, and genuine parts and accessories to properly service your engine should the need occur. He knows your engine best.

## Service Away from Home

If you are away from your local dealer and the need arises for service, contact the nearest authorized dealer. Refer to the Yellow Pages of the telephone directory. If, for any reason, you cannot obtain service, contact the nearest Mercury Marine Service Office.

## Parts and Accessories Inquiries

All inquiries concerning genuine replacement parts and accessories should be directed to your local authorized dealer. The dealer has the necessary information to order parts and accessories for you. When inquiring on parts and accessories, the dealer requires the model and serial number to order the correct parts.

## Service Assistance

Your satisfaction with your outboard product is very important to your dealer and to us. If you ever have a problem, question or concern about your outboard product, contact your dealer or any authorized Mercury Marine dealership. If additional assistance is required, take these steps.

1. Talk with the dealership's sales manager or service manager. If this has already been done, then contact the owner of the dealership.
2. Should you have a question, concern, or problem that cannot be resolved by your dealership, please contact Mercury Marine Service Office for assistance. Mercury Marine will work with you and your dealership to resolve all problems.

The following information will be needed by the service office:

- Your name and address
- Daytime telephone number
- Model and serial number of your outboard
- The name and address of your dealership

# OWNERS ASSISTANCE

- Nature of problem

## Mercury Marine Service Offices

For assistance, call, fax, or write. Please include your daytime telephone number with mail and fax correspondence.

<b>United States, Canada</b>		
Telephone	English - (920) 929-5040 Français - (905) 636-4751	Mercury Marine W6250 W. Pioneer Road P.O. Box 1939 Fond du Lac, WI 54936-1939
Fax	English - (920) 929-5893 Français - (905) 636-1704	
Website	www.mercurymarine.com	

<b>Australia, Pacific</b>		
Telephone	(61) (3) 9791-5822	Brunswick Asia Pacific Group 132-140 Frankston Road Dandenong, Victoria 3164 Australia
Fax	(61) (3) 9706-7228	

<b>Europe, Middle East, Africa</b>		
Telephone	(32) (87) 32 • 32 • 11	Brunswick Marine Europe Parc Industriel de Petit-Rechain B-4800 Verviers, Belgium
Fax	(32) (87) 31 • 19 • 65	

<b>Mexico, Central America, South America, Caribbean</b>		
Telephone	(954) 744-3500	Mercury Marine 11650 Interchange Circle North Miramar, FL 33025 U.S.A.
Fax	(954) 744-3535	

<b>Japan</b>		
Telephone	81-053-423-2500	Mercury Marine - Japan Anshin-cho 283-1 Hamamatsu Shizuoka-ken, Japan 435-0005 Japan
Fax	81-053-423-2510	

## OWNERS ASSISTANCE

<b>Asia, Singapore</b>		
Telephone	5466160	Mercury Marine Singapore 72 Loyang Way Singapore, 508762
Fax	5467789	

### Ordering Literature

Before ordering literature, please have the following information about your power package available:

<b>Engine Model:</b>		<b>Horsepower:</b>	
<b>Serial Number:</b>		<b>Model year:</b>	

### UNITED STATES AND CANADA

For information on additional literature that is available for your particular Mercury/MerCruiser power package and how to order that literature contact your nearest dealer or contact:

<b>MERCURY MARINE</b>		
<b>Telephone</b>	<b>Fax</b>	<b>Mail</b>
(920) 929-5110	(920) 929-4894	Mercury Marine Attn: Publications Department P.O. Box 1939 Fond du Lac, WI 54936-1939,

### OUTSIDE THE UNITED STATES AND CANADA

Contact your nearest dealer or Marine Power Service Center for information on additional literature that is available for your particular Mercury/MerCruiser power package and how to order that literature.