

# Stromlaufplan

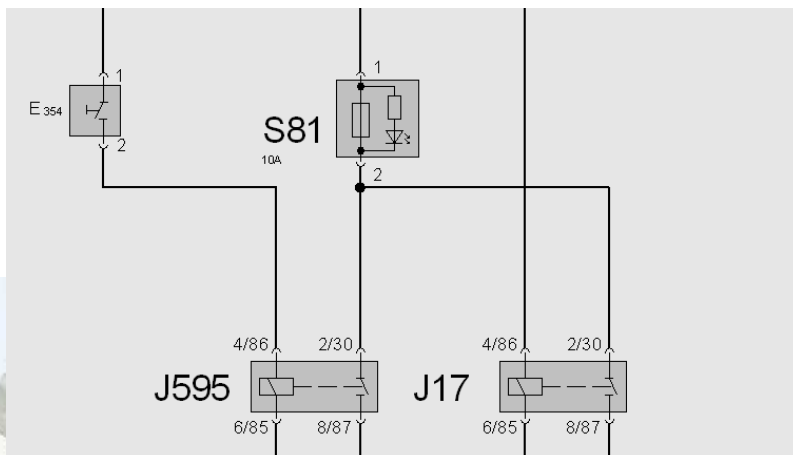

## Bootsmotoren von Volkswagen Marine

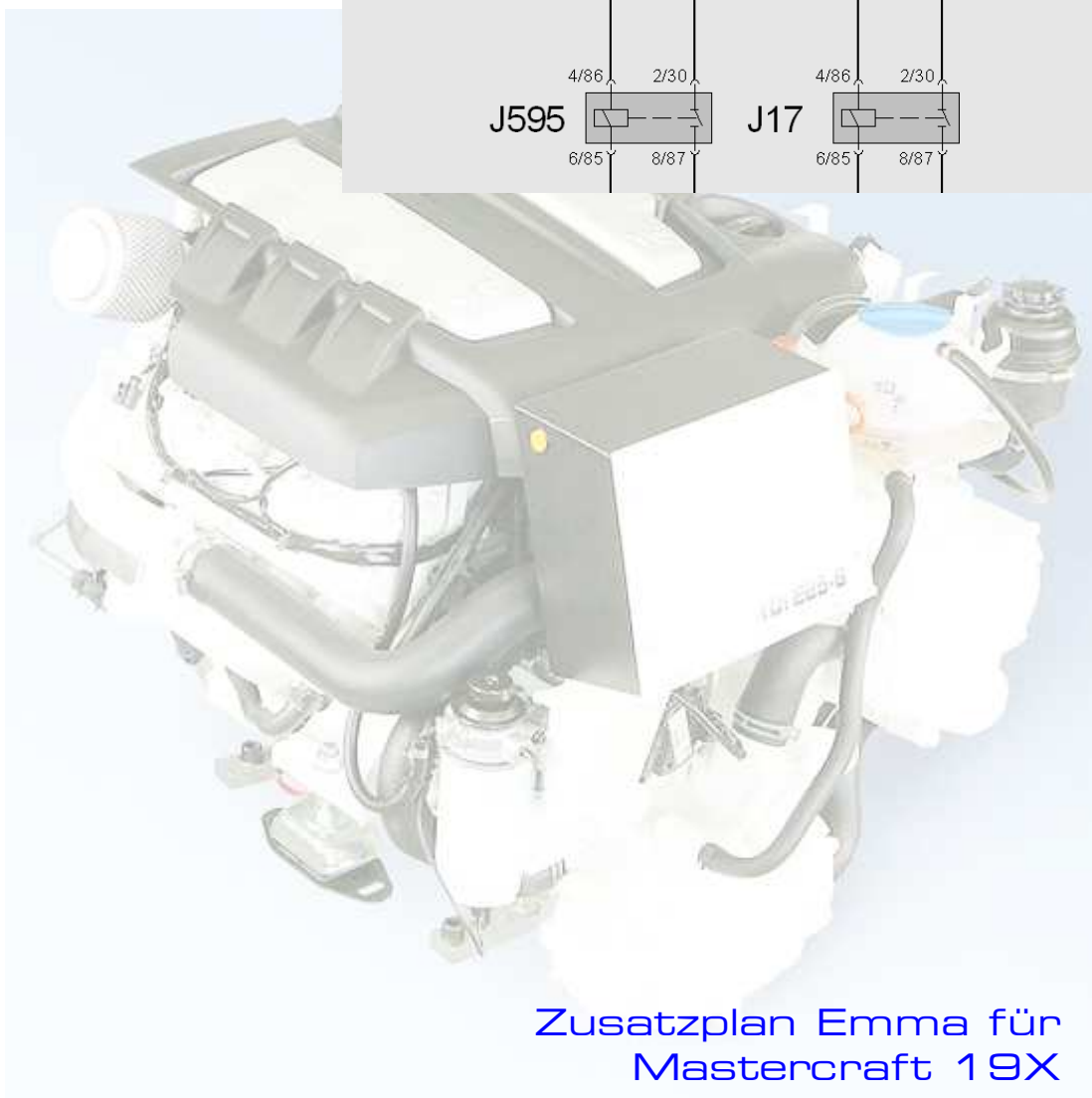

Zusatzplan Emma für  
Mastercraft 19X

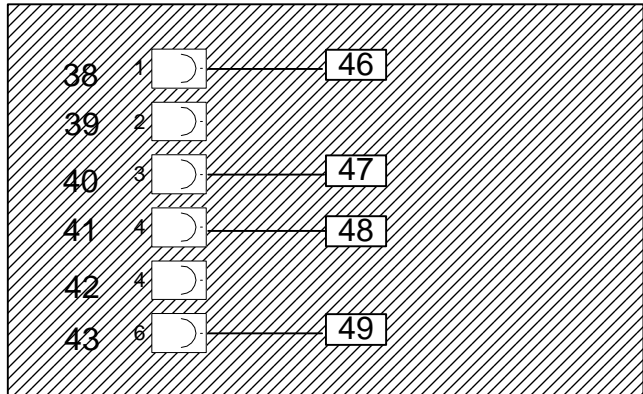
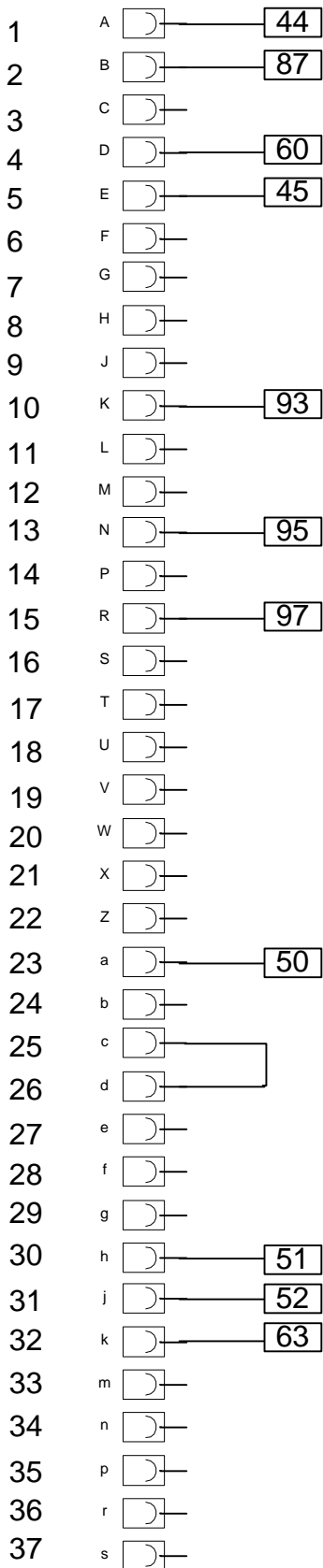

Übergabestelle am Motor  
Stecker T6 auf Seite 5  
des Stromlaufplanes slp-v6cr-ohne-instr-de  
- anstelle des PWG an den  
Motorleitungsstrang anstecken.

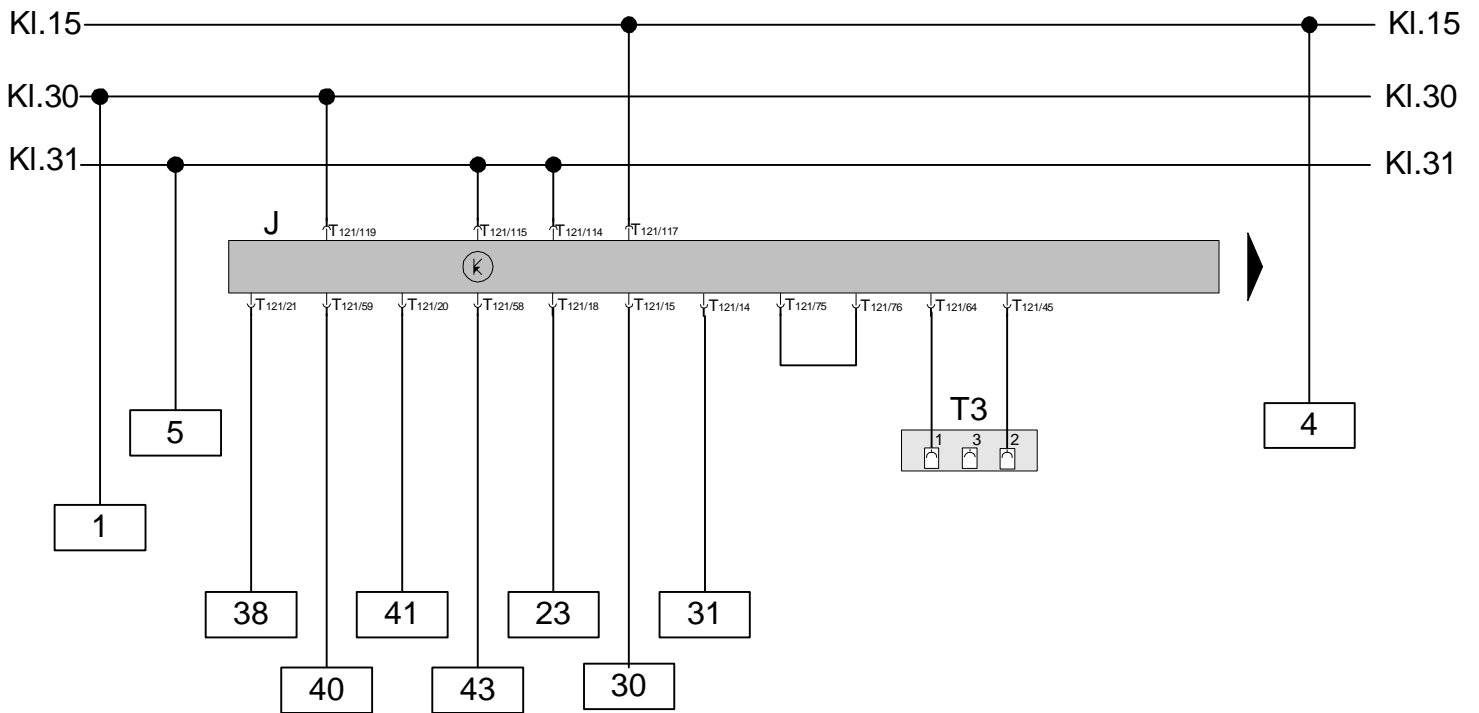

44 45 46 47 48 49 50 51 52 53 54 55 56 57 58 59 60 61

J EMMA  
T3 3poliger Diagnosestecker für EMMA

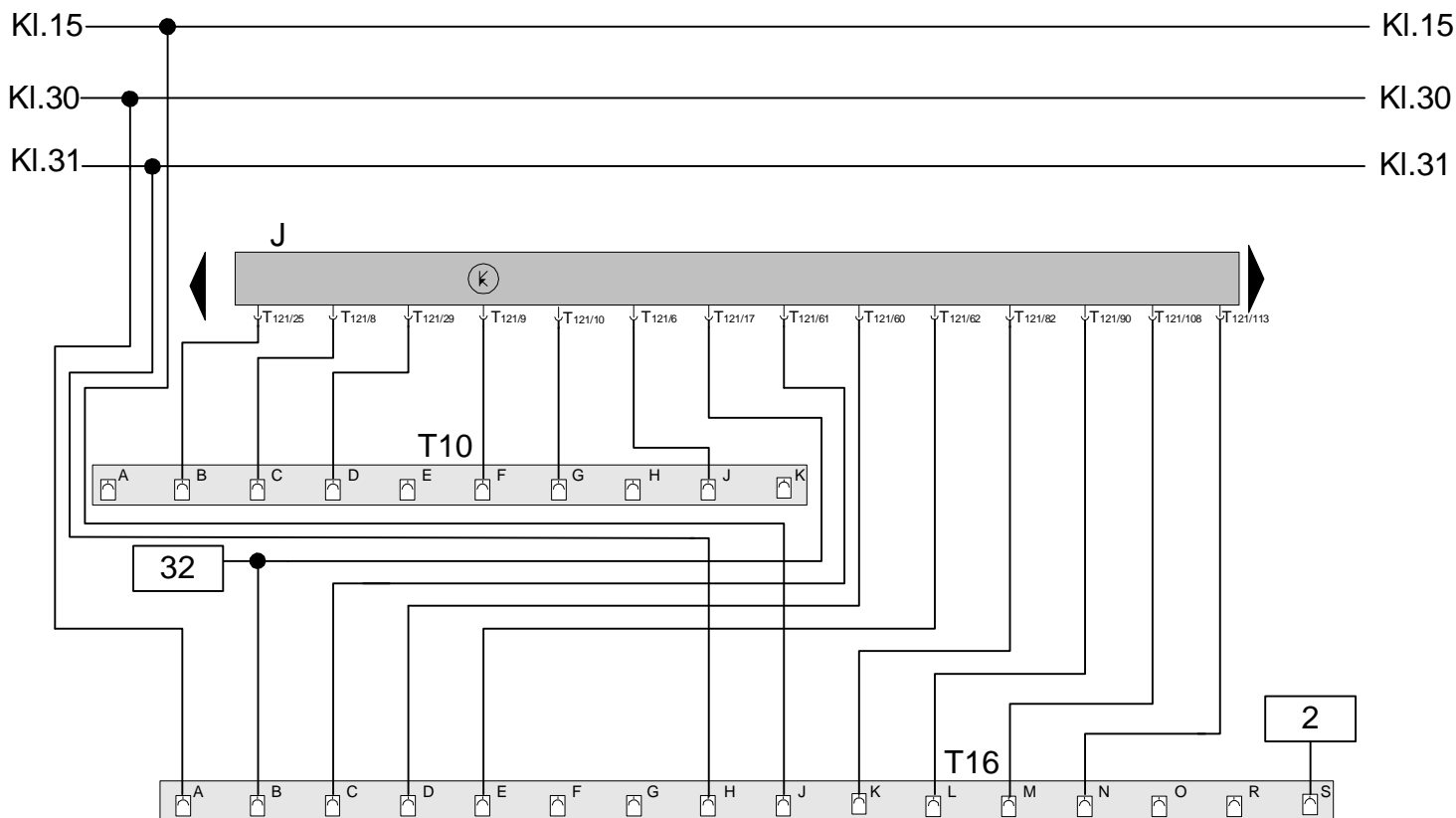

62 63 64 65 66 67 68 69 70 80 81 82 83 84 85 86 87 88

- J EMMA
- T10 10poliger Stecker zum Mastercraft Fahrhebel
- T16 16poliger Stecker zum Mastercraft Instrumentenleitungsstrang

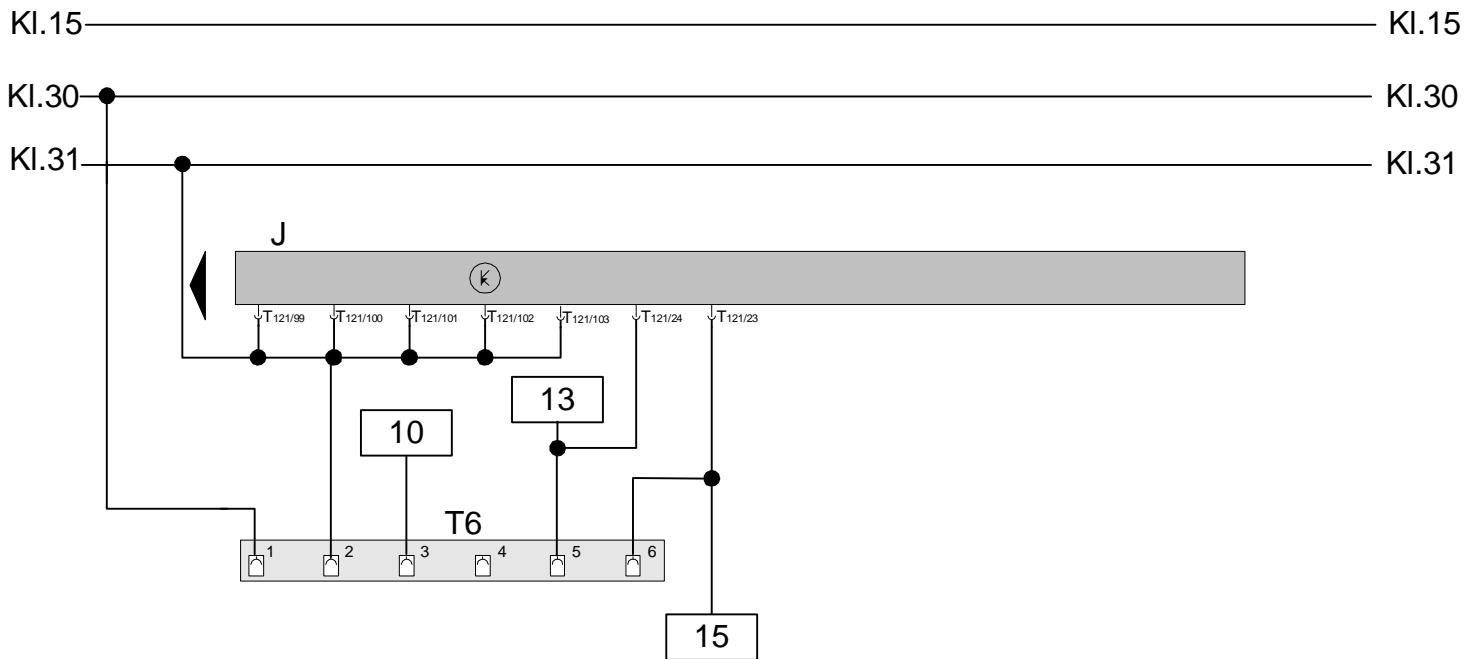

89 90 91 92 93 94 95 96 97 98 99 100 101 102 103 104 105 106

J EMMA  
T6 16poliger Diagnosestecker