

# SCC-1 SMARTCRAFT CONNECT GATEWAY INSTALLATION MANUAL

**IMPORTANT:** This document guides our dealers, boatbuilders, and company service personnel in the proper installation or service of our products. If you have not been trained in the recommended servicing or installation procedures for these or similar Mercury Marine products, have the work performed by an authorized Mercury Marine dealer technician. Improper installation or servicing of the Mercury product could result in damage to the product or personal injury to those installing or operating the product.

## Components in Kit

**NOTE:** The termination band on the 10-pin connector cable only applies to engine mounted modules.

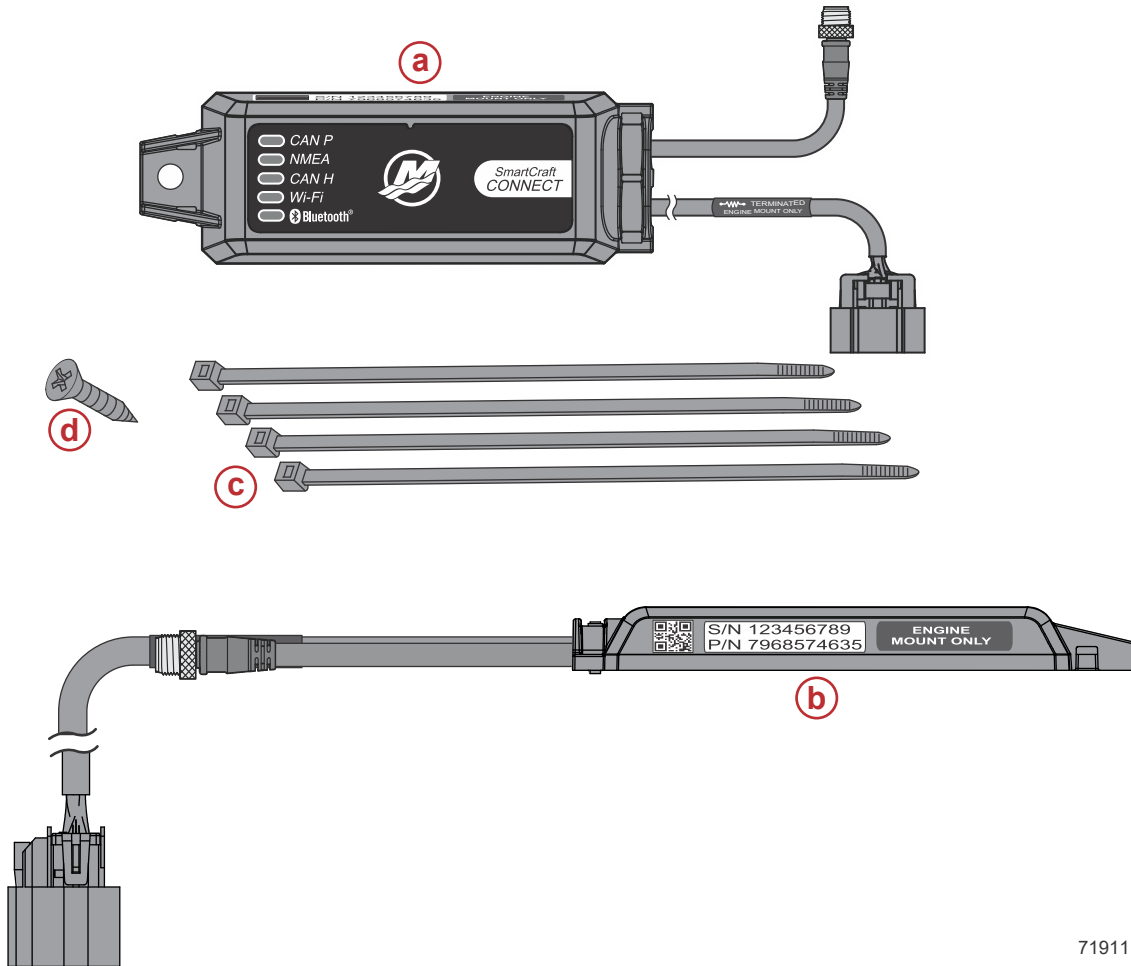

- a - SmartCraft CONNECT module
- b - SmartCraft CONNECT module - side view
- c - Cable ties - 4
- d - #10 x .88" stainless steel wood screw

## Features

The CAN P, CAN H, and NMEA lights will turn on when data is being transmitted through the Gateway.

**NOTE:** This manual covers the installation of CAN P only - engine mounted module (single). The helm mount module will default out of the box with CAN P and CAN H. CAN H is applicable to Dual, Triple, and Quad DTS engine applications. CAN H must be turned off if issues with the analog tachometers are encountered on mechanical/non-DTS products.

**NOTE:** VesselView Link and SmartCraft CONNECT cannot be used together on the same network. At the time of this publication the two cannot be used together, cross compatibility function will be included in a future firmware update.

## SmartCraft CONNECT Module—Single through Quad-Engine

**NOTE:** The Connect module does not provide power for any device on the NMEA 2000 network. The NMEA 2000 network will require its own power source. The NMEA 2000 network power input must have appropriate circuit protection for the devices on the NMEA 2000 network.

**NOTE:** The termination band on the 10-pin connector cable only applies to engine mounted modules.

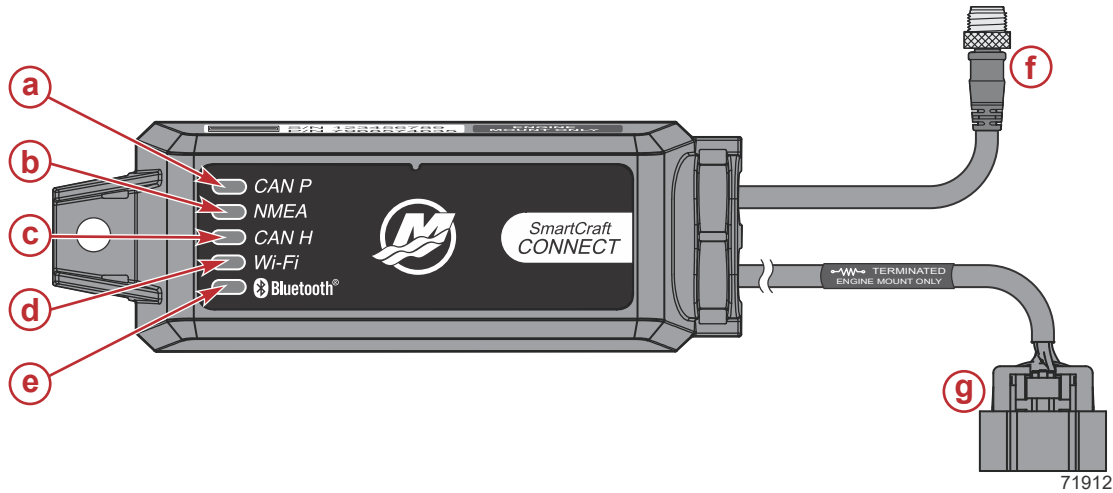

- a - CAN P connection light
- b - NMEA connection light
- c - CAN H connection light
- d - Wi-Fi connection light
- e - Bluetooth® connection light
- f - NMEA 2000® connector
- g - 10-pin connector

## Module Harness Connections

1. Connect the SmartCraft CONNECT module in one of the two following ways:
  - a. Connect the CAN 10-pin harness connector to the SmartCraft junction box. Refer to the following diagram.
  - b. Connect the CAN 10-pin harness connector to the helm harness SmartCraft 10-pin connection using a male-male adapter harness.
2. Connect the module NMEA 2000 harness connector to the NMEA 2000 network. A NMEA 2000 extension may be required to reach the NMEA 2000 backbone.

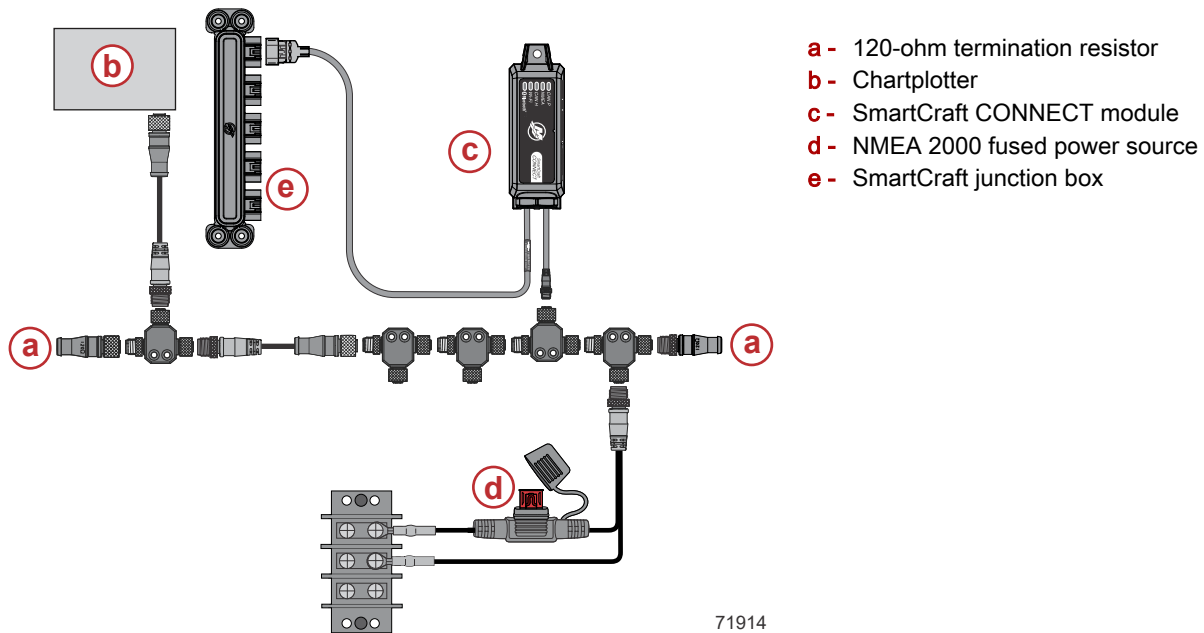

## On-Engine Mounting Guidelines

### Mounting Requirements

**NOTE:** The 10-pin on-engine terminator must be removed from the engine harness before installation of this module.

- The SmartCraft CONNECT module must be mounted in a location that allows for connection to the 10-pin connector on the engine harness. No additional 10-pin harnessing may be used in the installation of this product.
- All routing must adhere to harness installation bend parameter specifications. The minimum bend radius of any portion of the harness must be no less than 13 mm (0.5 in.).
- Two cable ties to secure the SmartCraft CONNECT module must be used to prevent unwanted movement during normal operation of the propulsion package.
- The following locations must be **avoided** when installing the SmartCraft CONNECT module.
  - Any location which can be exposed to water
  - Any location that is subject to high heat during operation of the power package
  - Near Ignition coils
  - Near spark plug wires
  - Near shift/throttle cables
  - Where harnessing could contact belts
  - Secured to fuel lines

### Module Configuration

**IMPORTANT:** Module configuration must be completed by a Mercury authorized dealer or boatbuilder. The SmartCraft Manager app is licensed to the dealer or boatbuilder.

**IMPORTANT:** For configuration of the SmartCraft CONNECT Module, a mobile device and a Wi-Fi connection with access to the internet is required.

**IMPORTANT:** If using a Garmin or Raymarine display, visit their website to make sure the display is running the latest software available.

1. Log on to the internet and download the **SmartCraft Manager** app from your iOS App Store or Google Play Store.



73578

2. After the app has been downloaded to your device, open the app to begin the configuration process.

3. Begin by entering the dealer number and license number.

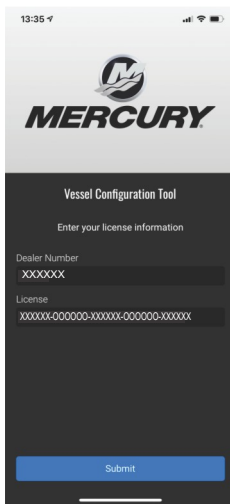

72604

4. Sign in to the appropriate existing account with the email and password credentials. If this is the first time setting up a SmartCraft CONNECT, an account must be created. Save the new account credentials for future use.

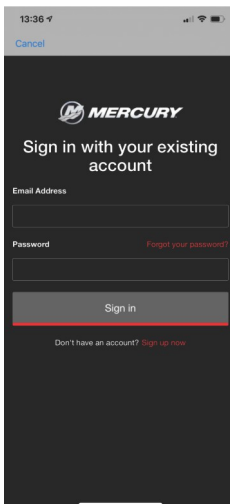

72605

5. Continue entering additional data on the next screen.
6. Power up the system with the key in the **ON** position.

7. Check that the SmartCraft CONNECT module and all other items on the boat are powered up. When these conditions are met, select **Find My Device**.

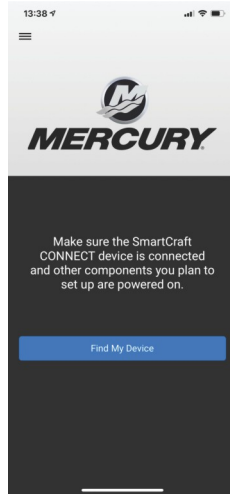

72606

8. The CONNECT module will appear on-screen along with a list of available Wi-Fi networks. Select a trusted network and connect.

**NOTE:** Networks that do not require a password are acceptable to use. Captive portal Wi-Fi networks, which require a user to interact with a web page, cannot be used to configure this module.

**NOTE:** The device name uses the last 3 digits of the module serial number for identification.

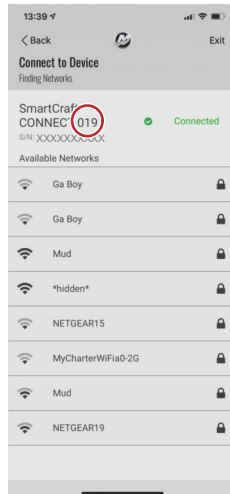

72607

9. Enter the network password and select **Connect**.

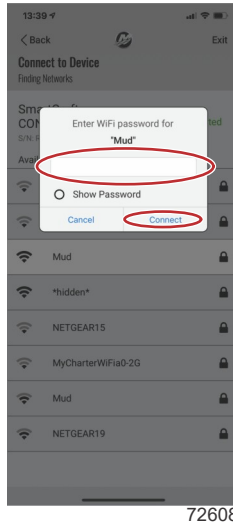

10. The SmartCraft CONNECT device will connect. Depending on the network strength, this may take a minute.

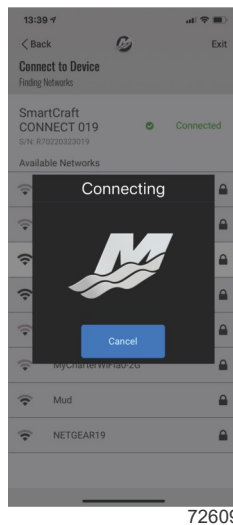

11. The menu screen will appear. The module will automatically query the Mercury site for any updates to the firmware. If any updates are needed, there will be an exclamation point in the upper right corner of the **Update Firmware** tile. In this event, click on that tile and any updates will begin.

**NOTE:** The app will say update complete when the module reflash is downloaded to the module. It will then restart, and may take a few minutes to perform the update. Do not remove battery power during this time.

**NOTE:** Complete any firmware updates before beginning the configuration process.

**NOTE:** Wait until the Wi-Fi LED on the device is solid, or a 'No Updates - 'Device is not ready to receive a firmware update'. message will appear.

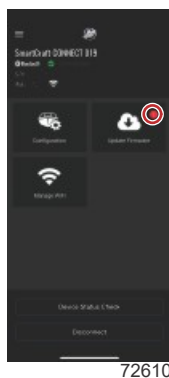

12. Select the **Configuration** tile on the screen.

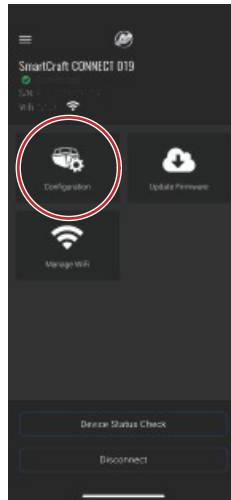

73580

13. Select **Configure Engines > Start**.

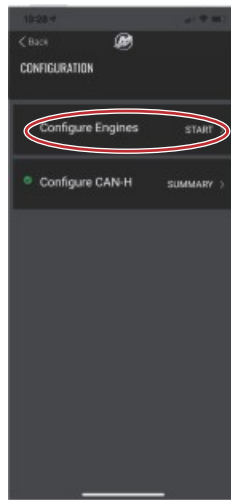

72814

14. Enter the correct information for the **Engine Type**, and **Engine Model**. Review your selections, and if everything is correct, select **Save**.

15. Continue by entering the engine serial number for the engine(s) supported by the module.

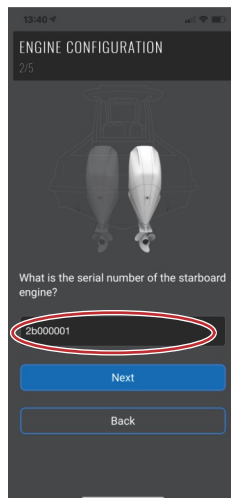

72613

16. Next, configure the CAN H connection by following the prompts on the screen.

**NOTE:** CAN H configuration only applies to boats with steer-by-wire systems; Joystick Piloting, outboard, sterndrive, or Zeus. If the boat is DTS or Non-DTS, the CAN H gateway can be left active.

17. Verify that the Wi-Fi LED is solid, indicating that the device has completed a cloud sync. If this is not verified, there is no certainty that the configuration was delivered to the module.

18. For tank configuration, return to the **CONFIGURATION** screen, and select the **Configure Tanks** option and select **START**.

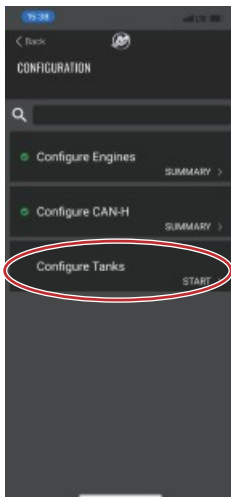

74053

19. Select the **Pencil Icon** within each tank field to edit and enter tank information.

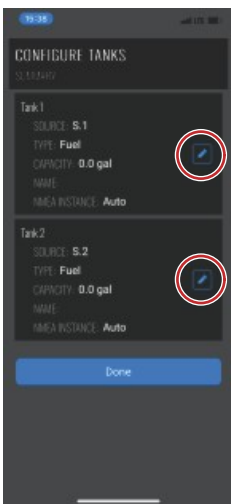

74035



20. Enter tank data and descriptions by selecting each option on the screen. Select **SAVE** after all information has been selected or input for each tank.

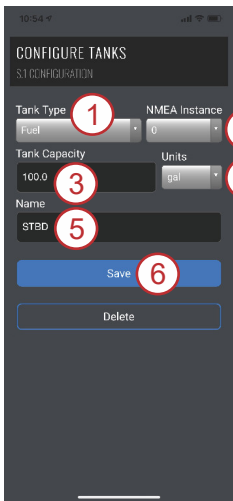

74037

- 1- Tank type drop-down menu
- 2- NMEA instance number  
*NOTE: The default will be "Auto". This option will only need to be changed on boats where there are multiple sources for tank levels on the N2K network.*
- 3- Tank volume capacity number  
*NOTE: A tank capacity of 0.0 will not show on the NMEA data stream. The capacity must be set greater than zero to show the tank level on NMEA.*
- 4- Tank volume unit drop-down menu
- 5- Customizable tank name
- 6- SAVE all current entries

21. Repeat this process for additional tanks on the vessel before navigating out of the configuration screens.



74143

## Troubleshooting

### Mobile Functionality

**IMPORTANT:** When using the app on Android devices, fine location detail must be shared with the app for proper function.

### LED Lighting

*NOTE: The Wi-Fi LED status troubleshooting chart is also available in the app.*



74028

The device contains 5 LEDs for indicating the status of CAN P, NMEA, CAN H, Wi-Fi, and Bluetooth®.

#### 1. CAN P

- **Flashing:** The LED will flash continuously once power is applied.
  - **Solid:** Once the bus communication is established, the LED will remain on.
2. **NMEA**
- **Flashing:** The LED will flash continuously once power is applied.
  - **Solid:** Once the bus communication is established, the LED will remain on.
3. **CAN H**
- NOTE: The CAN H LED will flash on any module connected to a mechanical engine, even if the CAN H BUS is disabled in the SmartCraft Manager.*
- **Flashing:** The LED will flash continuously once power is applied.
  - **Solid:** Once the bus communication is established, the LED will remain on.
4. **Wi-Fi**
- **Off:** No connection.
  - **Flashing:** Connected to a Wi-Fi access point. Attempting to sync with the Mercury cloud server.
  - **On:** Connected to a Wi-Fi access point and synced with the Mercury cloud server.
5. **Bluetooth**
- **Flashing:** The Bluetooth LED will flash while in pairing mode, indicating it is not currently connected.
  - **Solid:** The Bluetooth LED will remain on continuously while connected.

## Licensing Errors

- **LicensesExceeded:** You have exceeded the number of licenses issued to your dealer
- **InactiveDealer:** This account number is no longer active with Mercury Marine
- **InvalidDealer:** The account number entered was not found in Mercury Marine's records
- **InvalidLicenseKey:** The license key that was entered is not a valid key—typed it in wrong
- **LicenseKeyToAccountInvalid:** Either the account number or the license key does not match the purchase records
- **MachineBlackListed:** Your device was black listed by Mercury
- **LicenseKeyBlackListed:** Your license key was black listed by Mercury
- **SubscriptionExpired:** The subscription for this license key has expired
- **InactiveSubscription:** The subscription for this license key has been canceled by the subscriber
- **VersionMismatch:** License Key is not compatible with this version of software. Example, you tried to use a G3 license key for SC Manager
- **LicenseRegistrationFailed:** Contact Mercury Service

## SmartCraft CONNECT Module NMEA 2000 Information

The software is capable of transmitting (TX) information to, and receiving (RX) information from various parameter group number (PGN) products.

NMEA 2000 Network Power Information		Value
NMEA 2000 Load Equivalency Number (LEN)		1

SmartCraft CONNECT Module Modes	
Transmit (TX)	Receive (RX)
Transmits Mercury data to NMEA 2000 display devices.	Receives data from NMEA 2000 to display on Mercury devices.

Mercury Engine Data to NMEA 2000 Capable Products			
Signal	Special Information	NMEA 2000 PGN	Mode
Rated RPM	–	127498/0x1F20A	TX
Coolant pressure	–	127489/0x1F201	TX
Speed over water (paddle and pitot)	–	128259/0x1F503	TX
RPM (rapid update)	–	127488/0x1F200	TX
Voltage	–	127489/0x1F201	TX
Coolant temperature	–	127489/0x1F201	TX
Fuel pressure	–	127489/0x1F201	TX

Mercury Engine Data to NMEA 2000 Capable Products			
Signal	Special Information	NMEA 2000 PGN	Mode
Fuel level (percent, type)	2 tanks per engine up to 4 engines, tank 1 for each engine is type fuel 0X00, tank 2 for each engine is data not available 0X0F, Gateway will always assign STBD engine tanks 1 and 2 to NMEA tanks 0 and 1. PORT engine tanks 1 and 2 to NMEA tanks 2 and 3.	127505/0x1F211	TX
Fuel flow	-	127489/0x1F201	TX
Oil pressure	-	127489/0x1F201	TX
Oil temperature	-	127489/0x1F201	TX
Gear temp	-	127493/0x1F205	TX
Gear pressure	-	127493/0x1F205	TX
Boost pressure	-	127488/0x1F200	TX
Trim position	-	127488/0x1F200	TX
Rudder angle	-	127245/0x1F10D	TX
Depth	-	128267/0x1F50B	TX
Depth offset	-	128267/0x1F50B	TX
Seawater temp	-	130310/0x1FD06	TX
Engine hours	-	127489/0x1F201	TX
Alarm data	NMEA 2000 alarm data is limited and will only display "Check Engine" when an alarm is activated. Refer to the Mercury SmartCraft Gauges for descriptive fault text.	127489/0x1F201	TX
Tabs	-	130576/0x1FE10	TX
Course over ground	-	129026/0x9F802	RX/TX
Speed over ground	-	129026/0x9F802	RX/TX
GPS position	-	129025/0x1F801	RX
Gear position	-	127493/0x1F205	TX
Engine load (diesel)	-	127489/0x1F201	TX

SmartCraft CONNECT Module to NMEA 2000 Capable Products			
Signal	Special Information	NMEA 2000 PGN	Mode
Heading	-	127250/0x1F112	RX/TX
Waypoint ID	-	129284/0x1F904	RX
Waypoint position (latitude/longitude)	-	129284/0x1F904	RX
Cross track error	-	129283/0x1F903	RX
Manufacturer ID	Address claim (0 x 90 = Mercury)	060928/0xEE00	TX
Product info	-	126996/0x1F014	TX

## FCC and ISED Regulatory Information

This device complies with Part 15 of the FCC Rules and Innovation, Science and Economic Development Canada License-exempt RSS standard(s). Operation is subject to the following two conditions: 1) This device may not cause harmful interference, and 2) This device must accept any interference received, including interference that may cause undesired operation.

Cet appareil est conforme aux normes RSS exemptes de licence d'Innovation, Science et Développement économique Canada. Son fonctionnement est soumis aux deux conditions suivantes: 1) cet appareil ne doit pas provoquer d'interférences, et 2) cet appareil doit accepter toute interférence, y compris les interférences susceptibles de provoquer un fonctionnement indésirable de l'appareil.

Warning: Changes or modifications not expressly approved by the party responsible for compliance could void the user's authority to operate the equipment.

This equipment has been tested and found to comply with the limits for a Class B digital device, pursuant to Part 15 of the FCC Rules. These limits are designed to provide reasonable protection against harmful interference in a residential installation. This equipment generates, uses, and can radiate radio frequency energy, and if not installed and used in accordance with the instructions, may cause harmful interference to radio communications. However, there is no guarantee that interference will not occur in a particular installation. If this equipment does cause harmful interference to radio or television reception, which can be determined by turning the equipment off and on, the user is encouraged to try to correct the interference by one of the following measures:

- Reorient or relocate the receiving antenna.
- Increase the separation between the equipment and receiver.
- Connect the equipment into an outlet on a circuit different from that to which the receiver is connected.
- Consult the dealer or an experienced radio/TV technician for help.

### RF Exposure Considerations

To comply with FCC and Innovation, Science and Economic Development Canada RF exposure limits for general population / uncontrolled exposure, the antenna must be installed to provide a separation distance of at least 20cm from all persons and operating in conjunction with any other antenna or transmitter, except in accordance with FCC multi-transmitter product procedures.

Pour se conformer aux limites d'exposition aux RF de la FCC et d'Industrie Canada pour la population générale / exposition non contrôlée, l'antenne(s) utilisée pour ce transmetteur doit être installée pour fournir une distance de séparation d'au moins 20cm de toutes les personnes et fonctionnant conjointement avec une autre antenne ou émetteur, sauf en conformité avec les procédures de produits multi-émetteur FCC.